



HUMAN CARE

Your Life. Your Way.



Altair, HeliQ, HeliQ with
Power Traverse, Roomer S
Service Manual/Servicemanual/
Manuale di manutenzione



Content/Innehållsförteckning/Contenuto

English:

Altair:

Exploded view - Altair	4
Spare part kits	5
Opening the lift - Altair	7
Closing the lift - Altair	8
Reseting the service alarm – Altair	8
Changing the belt - Altair	9
Changing the battery - Altair	11

HeliQ:

Changing the hand control - Altair	12
Exploded view - HeliQ	13
Spare part kits - HeliQ	14
Opening the lift - HeliQ	16
Closing the lift - HeliQ	17
Reseting service alarm – HeliQ	17
Changing the belt - HeliQ	18
Changing the battery - HeliQ	20

Roomer S:

Changing the hand control - HeliQ	21
Exploded view - Roomer S	22
Spare part kits - Roomer S	23
Opening the lift - Roomer S	25
Closing the lift - Roomer S	26
Reseting service alarm – Roomer S	26
Changing the hand control - Roomer S	27
Changing the belt - Roomer S	28
Changing the battery - Roomer S	30

Svenska:

Altair:

Sprängskiss - Altair	32
Reservdelskit - Altair	33
Öppna lyften – Altair	35
Stänga lyften – Altair	36
Återställa servicealarm – Altair	36
Byta bältet – Altair	37
Byta batteri – Altair	39
Byta handkontrollen – Altair	40

HeliQ:

Sprängskiss - HeliQ	41
Reservdelskit - HeliQ	42
Reservdelskit - HeliQ	43
Öppna lyften - HeliQ	44
Stänga lyften - HeliQ	45
Återställa servicealarm – HeliQ	45
Byta bältet - HeliQ	46
Byta batteri - HeliQ	48
Byta handkontrollen - HeliQ	49

Roomer S:

Sprängskiss- Roomer S	50
Reservdelskit - Roomer S	51
Öppna lyften - Roomer S	53
Stänga lyften - Roomer S	54
Återställa servicealarm – Roomer S	54
Byta handkontrollen - Roomer S	55
Byta bältet - Roomer S	56
Byta batteri - Roomer S	58

Italienska:

Altair:

Vista esplosa - Altair	60
Kit parti di ricambio	61
Apertura del sollevatore - Altair	63
Chiusura del sollevatore - Altair	64
Ripristino dell'allarme di manutenzione — Altair	64
Cambio della cinghia - Altair	65
Sostituzione della batteria - Altair	67
Sostituzione del comando manuale - Altair	68

HeliQ:

Vista esplosa - HeliQ	69
Kit di ricambio - HeliQ	70
Apertura del sollevatore - HeliQ	72
Chiusura del sollevatore - HeliQ	73
Ripristino dell'allarme di manutenzione — HeliQ	73
Cambio della cinghia - HeliQ	74
Sostituzione della batteria - HeliQ	76
Sostituzione del comando manuale - HeliQ	77

Roomer S:

Vista esplosa - Roomer S	78
Kit di ricambio - Roomer S	79
Apertura del sollevatore - Roomer S	81
Chiusura del sollevatore - Roomer S	82
Ripristino dell'allarme di manutenzione — Roomer S	82
Sostituzione del comando manuale - Roomer S	83
Cambio della cinghia - Roomer S	84
Cambio della batteria - Roomer S	86

Exploded view - Altair

ENG

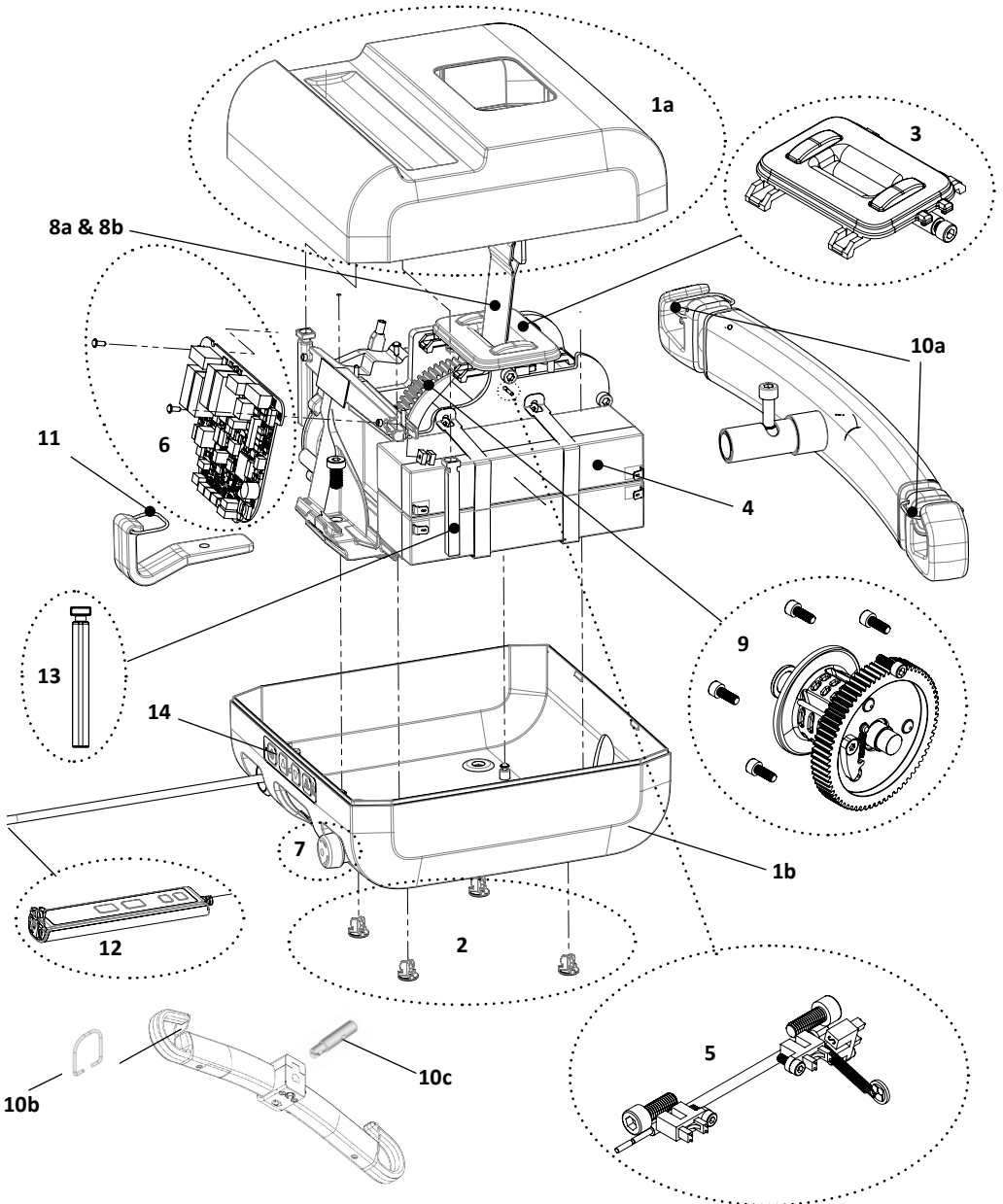

All spare parts for the overhead lifts are sold as kits. circled and pointed parts shows the kits that are available. Detailed list with included parts is shown at the next page.

Kit number in exploded view	Part no.	Spare parts kit	Included in kit	Quantity of pieces in kit
1a	71461	Top cover Altair - kit	Screw PT WN1452 K30x40 FZB	2
			Top cover Altair	1
1b	92937	Bottom Cover Altair	Cover 54027	1
			Label at customer specification (picture of original label required)	1
2	71445	Foot portable lift - kit	Foot portable lift	20
3	71463	Upper limit switch Altair HeliQ - kit	Belt guide Altair HeliQ	1
			Belt stop switch	2
			Belt idler shaft	1
			Screw MC6S M6x16 A2	2
4	71449	Battery overhead lift - kit	CT2.3-12_Battery	2
			3M VHB 5930 Double sided adhesive tape	2
4	71450	Battery overhead lift - kit	CT2.3-12_Battery	10
			3M VHB 5930 Double sided adhesive tape	10
5	71466	Beltstop sensor Altair HeliQ - kit	Belt stop sensor with 350 cable	2
			Belt tension guard sensor 1	1
			Spring Belt Tension Guard	1
			Washer Plastic BTG	1
			Washer-LB-A-4816	1
			Belt tension guard shaft	1
			Screw MC6S M3x8 A2-70	3
			Screw MC6S M6x16 A2	2
6	71474	Circuit board Altair 150kg - kit	Printed circuit board main Altair 150kg	1
			Screw PT WN1451 K30x8 FZB	2
			Washer Plastic 4.83x3.05x2.54	2
6	71475	Circuit board Altair 220kg - kit	Printed circuit board main Altair 220kg	1
			Screw PT WN1451 K30x8 FZB	2
			Washer Plastic 4.83x3.05x2.54	2
6	71476	Circuit board Altair 300kg - kit	Printed circuit board main Altair 300kg	1
			Screw PT WN1451 K30x8 FZB	2
			Washer Plastic 4.83x3.05x2.54	2
not in view	54437	Coin battery CR-1025_BN	Battery for main circuit board	1
7	71489	Emergency stop portable lift - kit	Emergency Stop 16	1

Kit number in exploded view	Part no.	Spare parts kit	Included in kit	Quantity of pieces in kit
8a	71483	Lift belt ceiling lift SWL 150kg/330lbs and 220kg/440lbs	Lift belt for Altair, Roomer S and HeliQ with lifting length 2120 mm	1
8b	71494	Lift belt ceiling lift SWL 300kg/660lbs - kit	Lift belt for ceiling lift Altair, Roomer S, HeliQ with lifting length 1720 mm	1
9	71467	Belt roll Altair HeliQ - kit	Screw MC6S M6x16 A2	6
			Belt roll Altair HeliQ	1
			Shaft belt roll Altair HeliQ	1
			Washer roll	1
10a	71455	Spring telescopic hanger bar ceiling lift - kit	Spring	10
10b	72803	Locking clips for hanger bar	Clips for hanger bars 72754, 72755, 72757, 55751, 55764, 92938	10
10c	92764	Shaft for hanger bar	For assembly of hanger bars 755751, 55764	1
11	71456	Spring stainless steel leg hook Altair, Roomer S - kit	Spring	5
not in view	92974	Spring coated leg hook Roomer S Altair	Clip for leg hook 92956	5
12	71457	Hand control Altair Roomer S - kit	Hand control Altair Roomer S without covers	1
			Strain Relief Clamp cc12	1
			Screw PT WN1452 K30x10 FZB	2
13	71462	Screw holder Altair HeliQ - kit	Screw Holder	10
14	71813	Secondary control panel Roomer S Altair HeliQ	Membrane panel Roomer S Altair HeliQ	1
not in view	71470	Charger Europe, overhead lift - kit	Battery Charger	1
			Charger Cable Europe	1
			Hand control holder	1
			Ring strap for holder	1
not in view	71471	Charger Great Britain, overhead lift - kit	Battery Charger	1
			Cable Charger Great Britain	1
			Hand control holder	1
			Ring strap for holder	1
not in view	71472	Charger Japan, overhead lift - kit	Battery Charger	1
			Cable Charger Japan	1
			Hand control holder	1
			Ring strap for holder	1
not in view	71473	Charger North America, overhead lift - kit	Battery Charger	1
			Cable Charger North America	1

Kit number in exploded view	Part no.	Spare parts kit	Included in kit	Quantity of pieces in kit
			Hand control holder	1
			Ring strap for holder	1
not in view	71491	Charger Australia overhead lift - kit	Battery charger	1
			Cable charger Australia	1
			Hand control holder	1
			Ring strap for holder	1
not in view	90407	Improvement color RAL9016		1
not in view	71811	Cover screw kit	Cover screw	10
not in view	92972	Secondary control panel RoomerS, Altair HeliQ	Membrane panel RoomerS, Altair, HeliQ	1

Opening the lift - Altair

ENG

1. Activate the emergency stop.



2. Turn the lift upside down. Be careful with the belt stop sensors.



3. Remove the rubber feet closest to the leg hook on the Altair lift.



4. Untighten the two screws with a torx screwdriver (TX10) holding the covers together (about 6-7 laps or until it's loosened). The screws are located at the bottom of the holes for the rubber feet/plastic.



5. Turn the lift around and remove the cover by angle it a bit towards the hanger bar until you hear a "click".

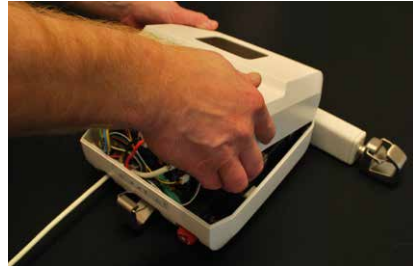

6. Always disconnect the battery cable when the cover is opened.

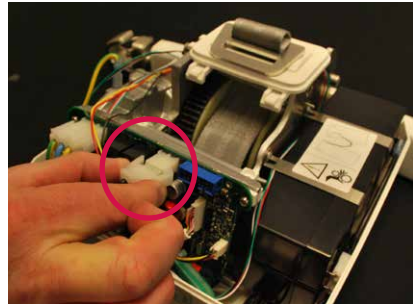

1. Make sure that all cables are connected as they were when opening the lift.
2. Make sure no cables are pinched between the covers.
3. Follow the steps 1-6 in the “opening the lift chapter” in reverse.

Don't forget the rubber feet!

Remember to attach all cables before closing the lift!

Reseting the service alarm – Altair

After the service is finished the service alarm should be reset.

- Connect the lift to a computer thru “Data and service application”. In the software, click service and log in with your login details. Click on the button “Reset service alarm”.



The screenshot shows the 'HUMAN CARE Data- och serviceapplikation' interface. The 'SERVICE' tab is selected. A button labeled 'ÅTERSTÄLL SERVICEALARM' is circled in red. Below it, there are buttons for 'UPPDATERA FIRMVARE' and 'STÄLL IN REALTIDSKLOCKA'. The 'SERVICE' section displays 'Senaste service' (2015-04-08) and 'Nästa servicebiljette' (2016-04-07). The 'FELRAPPORTER' section shows a table of error reports.

Datum	Tid	Beskrivning
2016-02-23	13:55	Nedkänning i nödsituationer
2016-02-23	13:55	Nedkänning i nödsituationer
2016-02-23	13:55	Nedkänning i nödsituationer
2016-02-23	13:55	Nedkänning i nödsituationer
2016-02-23	13:56	Nedkänning i nödsituationer

The belt can be changed without removing the belt outlet.

Follow the steps 1-5 in the “opening the lift chapter”.

1. Re-activate the emergency stop.
2. Unscrew the Opto-switch for the belt tension guard and turn it 90° in order to be able to freely operate the lift without weight.

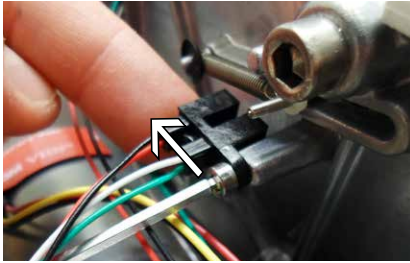

3. Drag the belt out all the way from the belt roll.

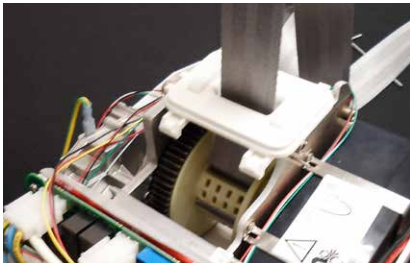

4. Create a big loop.



5. Use for example a spatula to create a loop on the other side.

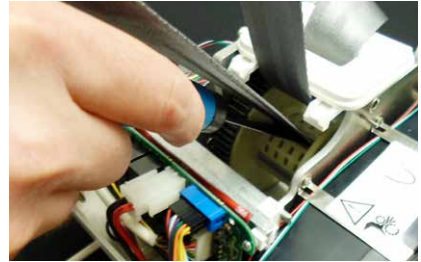

6. Press “up” button on the hand control to turn the belt roll and grab the loop.



7. Use the spatula again to get the end of the belt with the small pin out.



8. Return the belt roll with the up button on the hand control. Grab the belt.



9. Remove the pin, the belt is now loose.

10. To insert the new belt, do the steps in reverse.

After the new belt is assembled. Make sure to position the opto-switch to it's starting position!

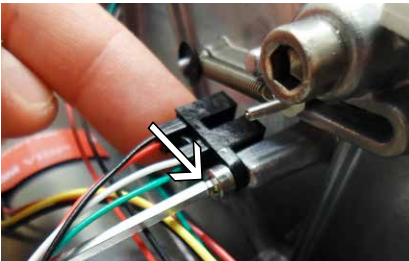

The battery pack consists of two 12 V, 2.3 Ah, lead type batteries. The lifetime is up to 5 years depending on charging and usage.

Replacing the battery:

1. Follow the steps 1-6 in the “opening the lift chapter”.
2. Try to not damage the warning label on top of the battery, for example by folding up the ends of the label.

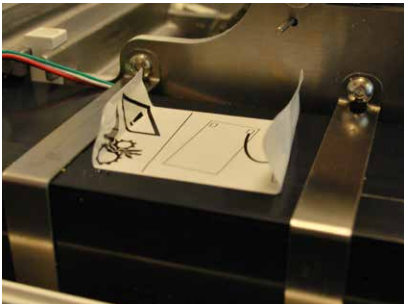

3. Unscrew the two metal brackets from the chassis by using a 2,5 mm Allen key.

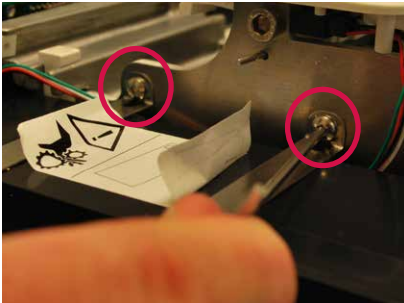

4. Lift up the battery pack from the lift.

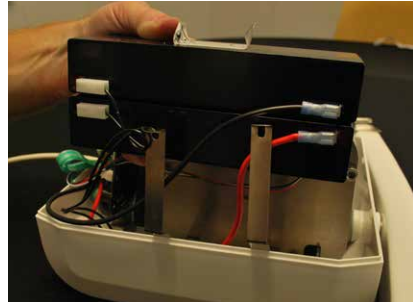

5. When the batteries is removed from the lift, disconnect all four cables.

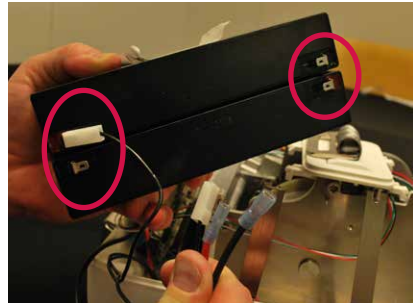

6. Fit the new batteries and re-connect the cables. Make sure the batteries are connected the same way as before the change.
7. Secure the battery cables between the battery (outside the steel brackets) and the lift cover.
8. Follow the steps 1-3 in reverse to complete the battery change.

1. Follow the steps 1-6 in the “opening the lift chapter”.
2. Remove the connector on the hand control cable from the circuit board (PCB) by pressing on the small plastic lock on the left side.

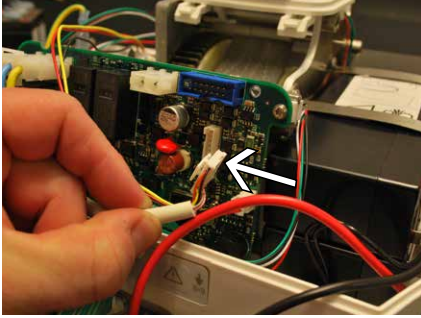

3. Remove the two screws from the cable holder with a torx screwdriver 10 mm (T10).

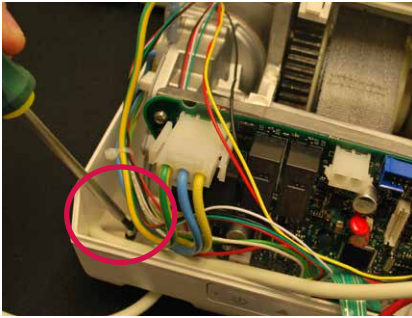

4. Remove the rubber seal from the cover.

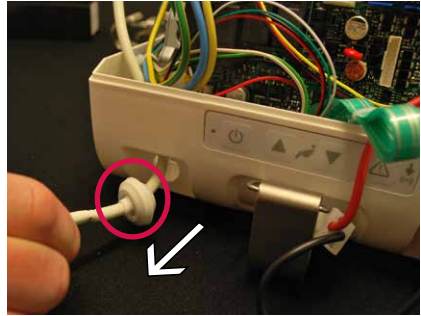

5. Pull the cable and the connector out through the hole.

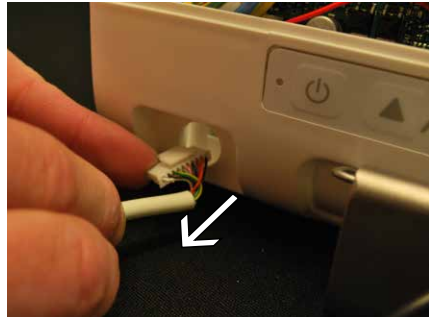

6. Repeat the steps in reverse in order to connect the new hand control.

If the hand control is damaged/broken, the cable can be cut to make it easier to remove the cable.

Exploded view - HeliQ

ENG

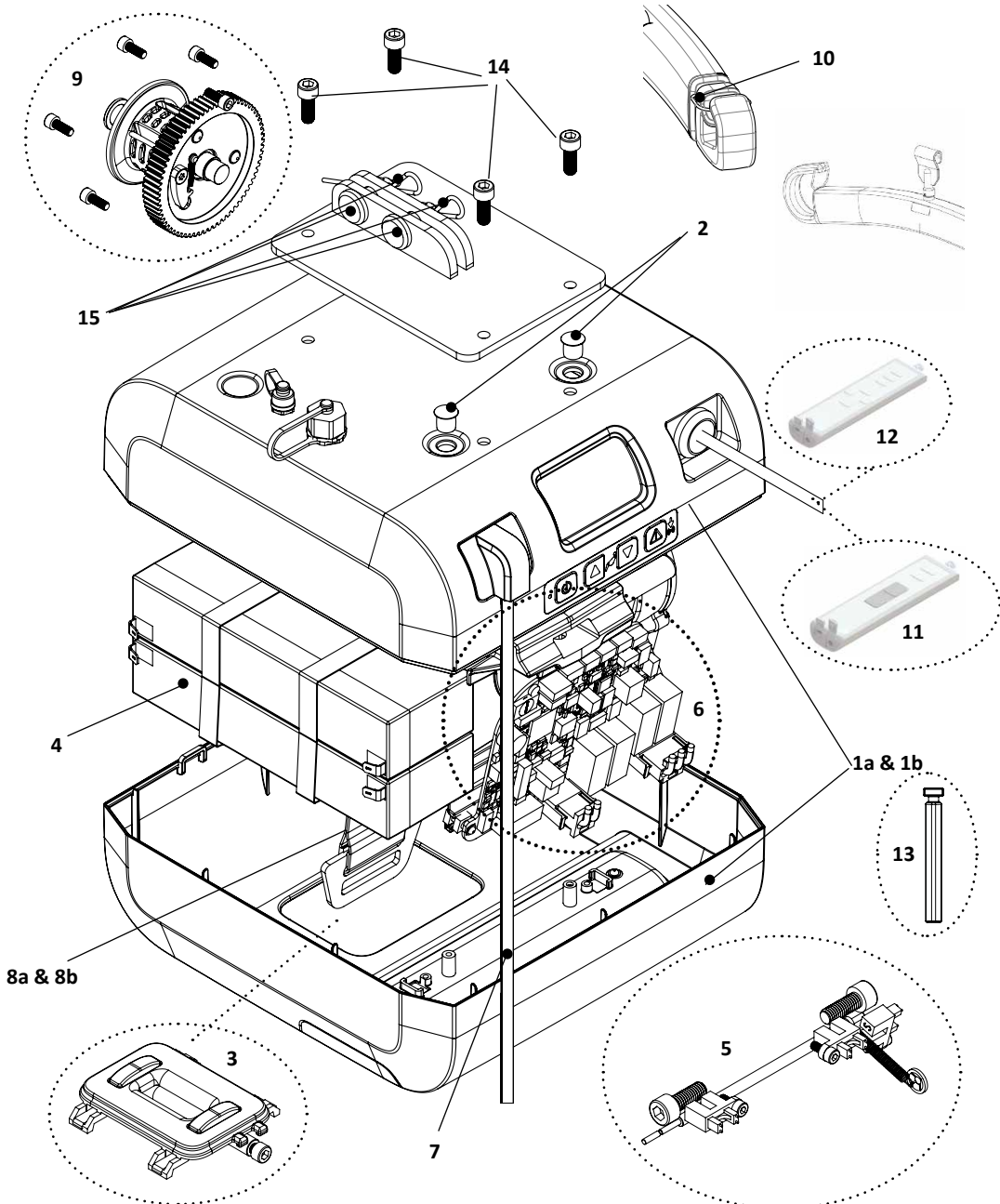

All spare parts for the overhead lifts are sold as a kits. circled and pointed parts shows the kits that are available. Detailed list with included parts is shown at the next page.

Kit number in exploded view	Part no.	Spare parts kit	Included in kit	Quantity of pieces in kit
1a	71464	Bottom cover HeliQ - kit	Screw PT WN1452 K30x40 FZB	2
			Bottom cover	1
1b	92971	Top cover HeliQ	Cover 54028	1
			Label at customer specifications (picture of original label required)	1
2	71465	Cover plug HeliQ - kit	Cover Plug 9.3	20
3	71463	Upper limit switch Altair HeliQ - kit	Belt guide Altair HeliQ	1
			Belt stop switch	2
			Belt idler shaft	1
			Screw MC6S M6x16 A2	2
4	71449	Battery overhead lift - kit	CT2.3-12_Battery	2
			3M VHB 5930 Double sided adhesive tape	2
4	71450	Battery overhead lift - kit	CT2.3-12_Battery	10
			3M VHB 5930 Double sided adhesive tape	10
5	71466	Beltstop sensor Altair HeliQ - kit	Belt stop sensor with 350 cable	2
			Belt tension guard sensor 1	1
			Spring Belt Tension Guard	1
			Washer Plastic BTG	1
			Washer-LB-A-4816	1
			Belt tension guard shaft	1
			Screw MC6S M3x8 A2-70	3
			Screw MC6S M6x16 A2	2
			Belt glider 1 pc.	1
6	71477	Circuit board HeliQ 150kg - kit	Printed circuit board main HeliQ 150kg	1
			Screw PT WN1451 K30x8 FZB	2
			Washer Plastic 4.83x3.05x2.54	2
6	71478	Circuit board HeliQ 220kg - kit	Printed circuit board main HeliQ 220kg	1
			Screw PT WN1451 K30x8 FZB	2
			Washer Plastic 4.83x3.05x2.54	2
6	71479	Circuit board HeliQ 300kg - kit	Printed circuit board main HeliQ 300kg	1
			Screw PT WN1451 K30x8 FZB	2
			Washer Plastic 4.83x3.05x2.54	2
not in view	54437	Coin battery CR-1025_BN	Battery coin for main circuit board	1

Kit number in exploded view	Part no.	Spare parts kit	Included in kit	Quantity of pieces in kit
7	71490	Emergency stop HeliQ - kit	Emergency Stop HeliQ	1
8a	71483	Lift belt ceiling lift SWL 150kg/330lbs and 220kg/440lbs	Lift belt for Altair, Roomer S and HeliQ with lifting length 2120mm	1
8b	71494	Lift belt ceiling lift SWL 300kg/660lbs - kit	Lift belt for ceiling lift Altair, Roomer S, HeliQ with SWL, lifting length 1720mm	1
9	71467	Belt roll Altair HeliQ - kit	Screw MC6S M6x16 A2	6
			Belt Roll Altair HeliQ	1
			Shaft Belt Roll Altair HeliQ	1
			Washer roll	1
10a	71455	Spring telescopic hanger bar ceiling lift - kit	Spring	10
10b	72803	Locking clips for hanger bar	Clips for hanger bars 72754, 72755, 72757, 55751, 55764, 92938	10
11	71458	Hand control HeliQ - kit	Hand control 4-button HeliQ without covers	1
			Strain Relief Clamp cc12	1
			Screw PT WN1452 K30x10 FZB	2
12	71459	Hand control HeliQ Power traverse - kit	Hand control 7-button HeliQ power traverse	1
			Strain Relief Clamp cc12	1
			Screw PT WN1452 K30x10 FZB	2
13	71462	Screw holder Altair HeliQ - kit	Screw Holder	10
14	71468	Top plate screw HeliQ - kit	Screw MC6S M6x16 A2-70	20
15	71469	Pin and locking pin HeliQ - kit	Locking needle	2
			Split pin CBH 20x25 fzb	2
not in view	71470	Charger Europe, overhead lift - kit	Battery Charger	1
			Cable Charger Europe	1
			Hand control holder	1
			Ring strap for holder	1
not in view	71471	Charger Great Britain, overhead lift - kit	Battery Charger	1
			Cable Charger Great Britain	1
			Hand control holder	1
			Ring strap for holder	1
not in view	71472	Charger Japan, overhead lift - kit	Battery Charger	1
			Cable Charger Japan	1
			Hand control holder	1
			Ring strap for holder	1
not in view	71473	Charger North America, overhead lift - kit	Battery Charger	1
			Cable Charger North America	1
			Hand control holder	1

Kit number in exploded view	Part no.	Spare parts kit	Included in kit	Quantity of pieces in kit
			Ring strap for holder	1
not in view	71491	Charger Australia, overhead lift - kit	Battery Charger	1
			Cable Charger Australia	1
			Hand control holder	1
			Ring strap for holder	1
not in view	90407	Improvement color RAL9016		1
not in view	71811	Cover screw kit	Cover screw	10
not in view	92972	Secondary control panel RoomerS, Altair, HeliQ	Membrane panel Roomer S Altair HeliQ	1

Opening the lift - HeliQ

ENG

1. Activate the emergency stop.



2. Remove the top plate screws using a 5 mm Allen key. Remove the top plate.



3. Remove the two cover plugs.

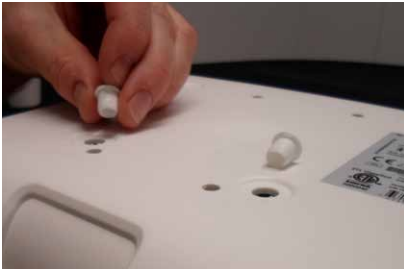

4. Untighten the two screws with a torx screwdriver (TX10) holding the covers together.



5. Turn the lift around and remove the cover by angle it a bit towards the opposite side of the control panel until you hear a "click".



6. Always disconnect the battery cable when the cover is opened.

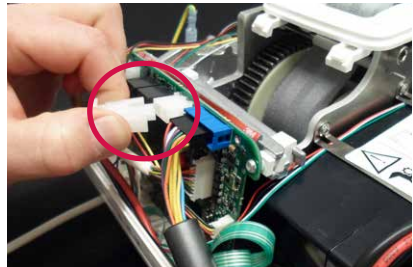

1. Make sure that all cables are connected as they were when opening the lift.
2. Make sure no cables are pinched between the covers.
3. Follow the steps 1-6 in the “opening the lift chapter” in reverse.

Don't forget the cover plugs!

Remember to attach all cables before closing the lift!

Reseting service alarm – HeliQ

After the service is finished the service alarm should be reset.

- Connect the lift to a computer thru “Data and service application”. In the software, click service and log in with your login details. Click on the button “Reset service alarm”.

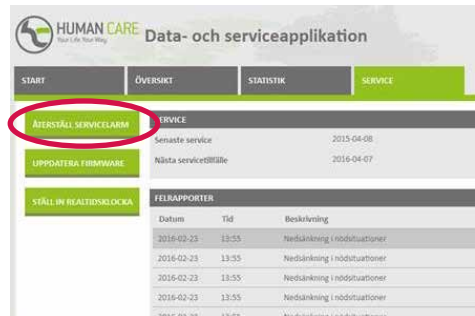

The screenshot shows the 'HUMAN CARE Data- och serviceapplikation' interface. The top navigation bar includes 'START', 'ÖVERSIKT', 'STATISTIK', and 'SERVICE'. The 'SERVICE' tab is active. Below the navigation bar, there are three main sections: 'ÅTERSTÄLL SERVICEALARM' (highlighted with a red circle), 'UPPDATERA FIRMWARE', and 'STÄLL IN REALTIDSKLOCKA'. The 'SERVICE' section displays 'Senaste service' (2015-04-08) and 'Nästa serviceStälle' (2016-04-07). The 'FELRAPPORTER' section shows a table of error reports.

Datum	Tid	Beskrivning
2016-02-23	13:55	Nedsläckning i nödsituationer
2016-02-23	13:55	Nedsläckning i nödsituationer
2016-02-23	13:55	Nedsläckning i nödsituationer
2016-03-23	13:55	Nedsläckning i nödsituationer
2016-03-23	13:55	Nedsläckning i nödsituationer

The belt can be changed without removing the belt outlet.

Follow the steps 1-5 in the “opening the lift chapter”.

1. Re-activate the emergency stop.
2. Unscrew the Opto-switch for the belt tension guard and turn it 90° in order to be able to freely operate the lift without weight.

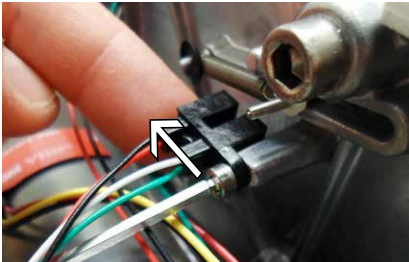

3. Drag the belt out all the way from the belt stop.

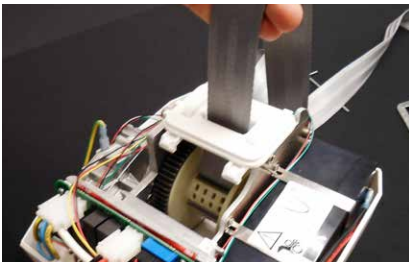

4. Create a big loop.



5. Use for example a spatula to create a loop on the other side.

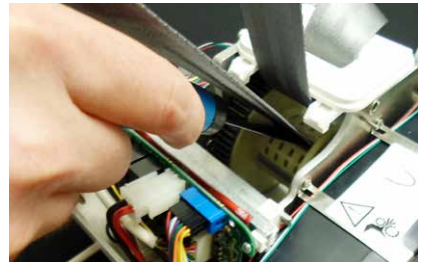

6. Press “up” button on the hand control to turn the belt roll and grab the loop.



7. Use the spatula again to get the end of the belt with the small pin out.



8. Return the belt roll with help of the hand control (up-button). Grab the belt.

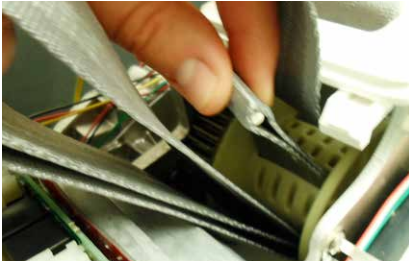

9. Remove the pin and the belt is loose.

9. To insert the new belt, do the steps in reverse.

After the new belt is assembled. Make sure to position the opto-switch to it's starting position!

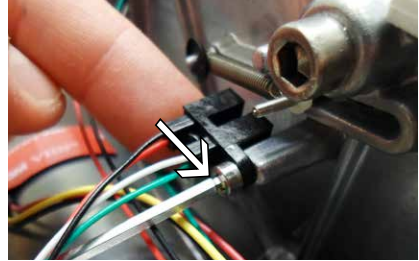

The battery pack consists of two 12 V, 2.3 Ah, lead type batteries. The lifetime is up to 5 years depending on charging and usage.

Replacing the battery:

1. Follow the steps 1-6 in the “opening the lift chapter”.
2. Try to not damage the warning label on top of the battery, for example by folding up the ends of the label.

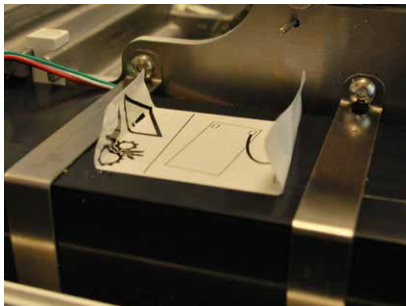

3. Unscrew the two metal brackets from the chassis by using a 2,5 mm Allen key.

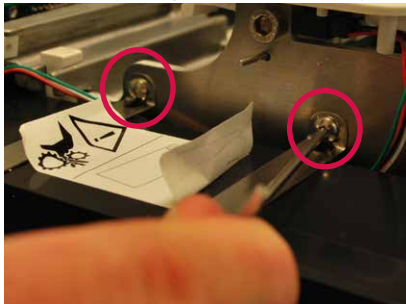

4. Lift up the battery pack from the lift.

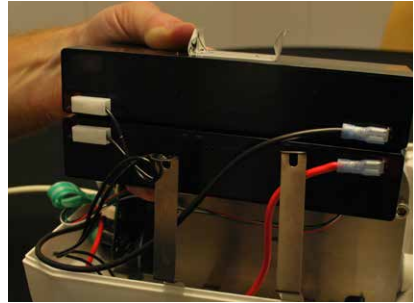

4. When the batteries is removed from the lift, disconnect all four cables.

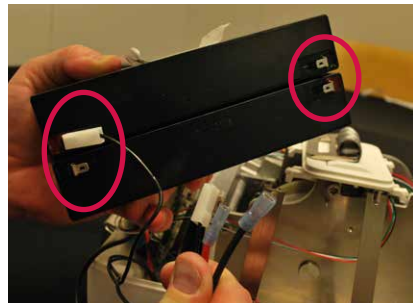

5. Fit the new batteries and re-connect the cables. Make sure the batteries are connected the same way as before the change.
6. Secure the battery cables between the battery (outside the steel brackets) and the lift cover.
7. Follow the steps 1-3 in reverse to complete the battery change.

1. Follow the steps 1-6 in the “opening the lift chapter”.
2. Remove the connector on the hand control cable from the circuit board (PCB) by pressing on the small plastic lock on the left side.

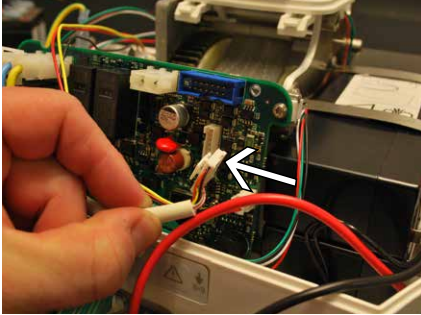

3. Remove the two screws from the cable holder with a torx screwdriver 10 mm (T10).

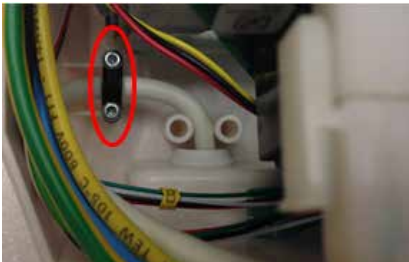
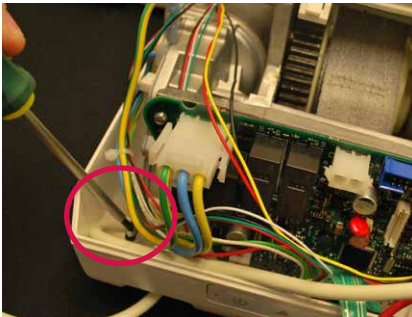

4. Remove the rubber seal from the cover.

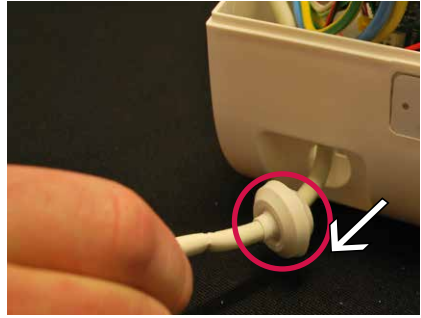

5. Pull the cable and the connector out through the hole.

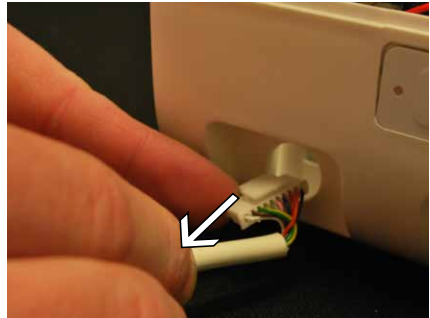

6. Repeat the steps in reverse in order to connect the new hand control.

If the hand control is damaged/broken the cable can be cut for easier removing of the hand control and cable.

Exploded view - Roomer S

ENG

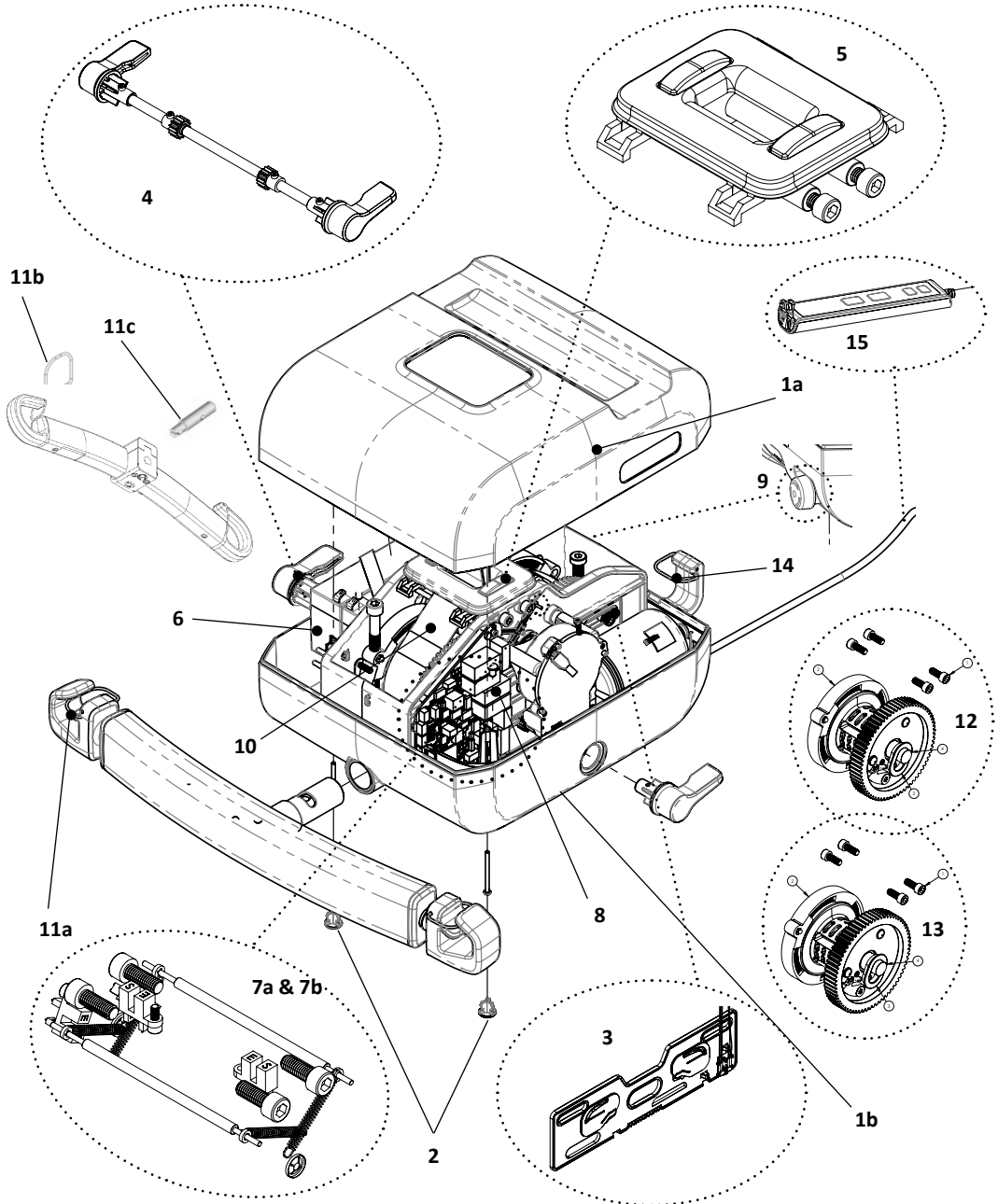

All spare parts for the overhead lifts are sold as a kits. circled and pointed parts shows the kits that are available. Detailed list with included parts is shown at the next page.

Kit number (exploded view)	Part no.	Spare parts kit	Included in kit	Quantity of pieces in kit
1a	71460	Top cover Roomer S - kit	Screw PT WN1452 K30x40 fzb	2
			Top cover Roomer S	1
1b	92936	Bottom Cover Roomer S kit	Cover 54055	1
			Label at customer specifications (picture of original label required)	1
2	71445	Foot Portable lift - kit	Foot portable lift	20
3	71446	Slider Roomer S - kit	Screw MC6LS M6x16	3
			Screw MC6S M6x16 A2	4
			Slider with sensor	2
4	71447	Switch Roomer S - kit	Roomer S switch lever	2
			Shaft Slider	1
			Screw MC6S M3x12 A2	4
			10015-N08 Mekanex	2
			Slide bearing 8x9x3	2
5	71448	Upper limit switch Roomer S - kit	Belt guide Roomer S	1
			Belt stop switch Roomer S	2
			Belt idler shaft Roomer S	2
			Screw MC6S M6x16 A2	4
6	71449	Battery overhead lift - kit	CT2.3-12_Battery	2
			3M VHB 5930 Double sided adhesive tape	2
6	71450	Battery overhead lift - kit	CT2.3-12_Battery	10
			3M VHB 5930 Double sided adhesive tape	10
7a	71451	Beltstop sensor Roomer S - kit	Belt stop sensor with 350 cable	1
			Belt stop sensor with 400 cable	1
			Belt tension guard sensor 2	1
			Belt tension guard sensor 1	1
			Spring belt tension guard	4
			Washer Plastic BTG	4
			Washer-LB-A-4816	2
			Belt tension guard shaft Belt tension guard shaft	2
			Screw MC6S M3x8 A2-70	4
			Screw MC6S M6x16 A2	4
			Belt glider	2
			Cable ties 2,5x100	3
			7b	71551

Kit number in exploded view	Part no.	Spare parts kit	Included in kit	Quantity of pieces in kit
8	71452	Circuit board Roomer S - kit	Printed circuit board main Roomer S 220 kg	1
			Screw MC6S M3x8 A2-70	3
not in view	54437	Coin battery CR-1025_BN	Battery coin for main circuit board	1
9	71489	Emergency stop portable lifts - kit	Emergency Stop 16	1
10a	71483	Lift belt ceiling lift SWL 150kg/330lbs and 220kg/440lbs	Lift belt for Altair, Roomer S and HeliQ with lifting length 2120mm	1
10b	71494	Lift belt ceiling lift SWL 300kg/660lbs - kit	Lift belt for ceiling lift Altair, Roomer S, HeliQ with SWL, lifting length 1720mm	1
11a	71455	Spring telescopic hanger bar ceiling lift - kit	Spring	10
11b	72803	Locking clips for hanger bar	Clips for hanger bars 72754, 72755, 72757, 55751, 55764, 92938	10
11c	92764	Shaft hanger bar Altair, Roomer S	For assembly of hanger bar 55751 and 55764	1
12	71453	Belt roll clock wise Roomer S -kit	Screw MC6S M6x16 A2	4
			Belt roll clock wise	1
			Bushing for belt roll shaft	2
			Shaft Belt Roll	1
13	71454	Belt roll counter clock wise Roomer S - kit	Screw MC6S M6x16 A2	4
			Belt roll counter clock wise	1
			Bushing for belt roll shaft	2
			Shaft Belt Roll	1
14a	71456	Spring stainless steel leg hook Altair Roomer S - kit	Spring	5
not in view	92974	Spring coated leg hook Altair Roomer S - kit	Spring for leg hook 92956	5
15	71457	Hand control Altair Roomer S - kit	Hand control portable lifts without cover	1
			Strain Relief Clamp cc12	1
			Screw PT WN1452 K30x10 FZB	2
not in view	71470	Charger Europe, overhead lift - kit	Battery Charger	1
			Cable Charger Europe	1
			Hand control holder	1
			Ring strap for holder	1
not in view	71471	Charger Great Britain, overhead lift - kit	Battery Charger	1
			Cable Charger Great Britain	1
			Hand control holder	1

Kit number in exploded view	Part no.	Spare parts kit	Included in kit	Quantity of pieces in kit
			Ring strap for holder	1
not in view	71472	Charger Japan, overhead lift - kit	Battery Charger	1
			Cable Charger Japan	1
			Hand control holder	1
			Ring strap for holder	1
not in view	71473	Charger North America, overhead lift - kit	Battery Charger	1
			Cable Charger North America	1
			Hand control holder	1
			Ring strap for holder	1
not in view	71491	Charger Australia, overhead lift - kit	Battery Charger	1
			Cable Charger Australia	1
			Hand control holder	1
			Ring strap for holder	1
not in view	90407	Improvement color RAL9016		1
not in view	71811	Cover screw kit	Cover screw	10
not in view	92972	Secondary control panel RoomerS, Altair, HeliQ	Membrane panel Roomer S Altair HeliQ	
not in view	92973	Battery holder kit	54905 Battery holder RoomerS	1
			55629 Heat shrink tubing	1

Opening the lift - Roomer S

ENG

1. Activate the emergency stop.



2. Turn the lift upside down. Be careful with the belt stop sensor.



3. Remove the rubber feet closest to the hanger bar on Roomer S lift.



4. Untighten the two screws (TX10) holding the covers together. The screws are located at the bottom of the holes for the rubber feet.



5. Turn the lift around and remove the cover by angle it a bit towards the opposite side of the control panel until you hear a "click".



6. Always disconnect the batteries when the cover is opened.

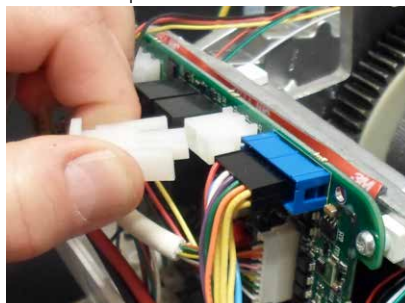

Closing the lift - Roomer S

ENG

1. Make sure that all cables are connected as they were before.
2. Make sure no cables are pinched.
3. Follow the steps 1-6 in the “opening the lift chapter” in reverse.

Remember to attach the battery cable before closing the lift!

Don't forget the rubber feet!

Reseting service alarm – Roomer S

ENG

After the service is finished the service alarm should be reset.

- Connect the lift to a computer thru “Data and service application”. In the software, click service and log in with your login details. Click on the button “Reset service alarm”.



The screenshot shows the HUMAN CARE Data- och serviceapplikation interface. The main navigation bar includes 'START', 'ÖVERSIKT', 'STATISTIK', and 'SERVICE'. The 'SERVICE' tab is active. Below the navigation bar, there are three main sections: 'ÅTERSTÄLL SERVICEALARM' (highlighted with a red circle), 'LIPPODATA FÖRÄNDRARE', and 'STÄLL IN REALTIDSKLOCKA'. The 'SERVICE' section displays 'Senaste service' (2015-04-08) and 'Nästa serviceöförelse' (2016-04-07). The 'FELRAPPORTER' section shows a table of error reports.

Datum	Tid	Beskrivning
2016-02-23	13:35	Nedjärkning i nödsituationer
2016-02-23	13:35	Nedjärkning i nödsituationer
2016-02-23	13:35	Nedjärkning i nödsituationer
2016-02-23	13:35	Nedjärkning i nödsituationer
2016-02-23	13:35	Nedjärkning i nödsituationer

1. Follow the steps 1-6 in the "opening the lift chapter".
2. Remove the connector on the hand control cable from the circuit board (PCB) by pressing on the small plastic lock on the top.

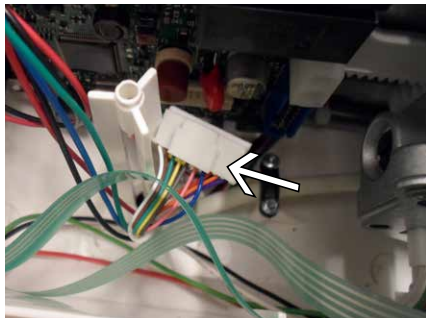
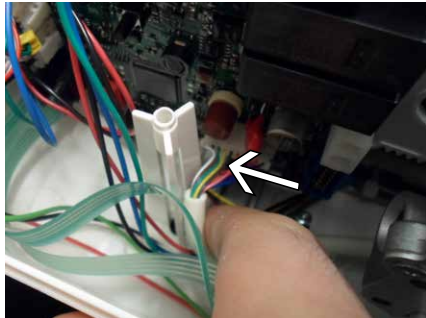

3. Remove the rubber seal from the cover.



4. Use for example a screwdriver to flip over

the cable to the left side like in pictures below.



5. Pull the cable and the connector out through the hole. If the hand control is damaged, you can cut the cable and it will be easier to pull out.

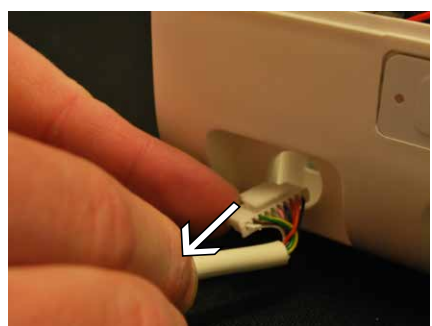

6. Repeat the steps in reverse in order to connect the new hand control.

Changing the belt - Roomer S

ENG

The belt can be changed without removing the belt outlet.

1. Drag the unlocked belt out all the way from the belt roll counter.

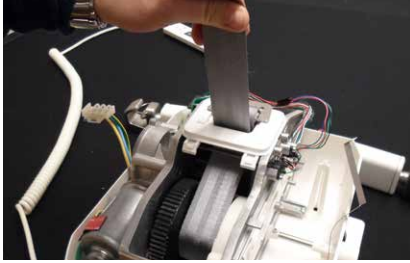

2. Create a quite big loop.

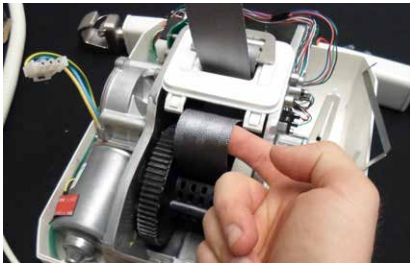

3. Use for example a spatula to create a loop on the other side.



5. Use the roomer S switch or the hand control to turn the belt roll and grab the loop.

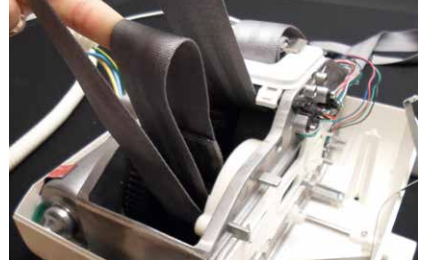

6. Use the spatula again to get the end of the belt with the small pin out.



7. Return the belt roll with help of the Rooter S switch or the hand control. Grab the belt.



Note! Do not turn the Rooter Switch without holding the belt roll since the spring will unwind. If you drop the belt roll, rewind the belt roll 9,5 turns from the belt roll slot with a metal pin.

7. Remove the pin and the belt is loose.



8. If you need to remove both belts, do the same on the opposite side.

9. Insert the new belt/belts through the belt outlet as shown in the picture below.

Note! Make sure the black tags on both belts are facing each other.

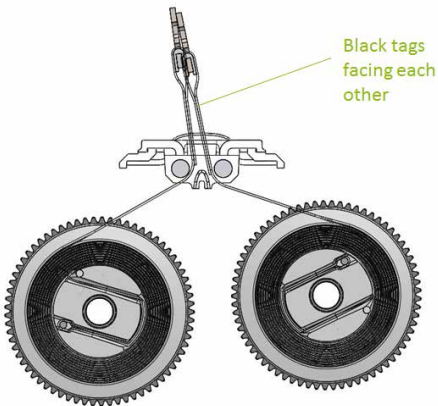

Note! Make sure the belts are on the correct side of the Belt tension guard.

- The belt should enter the belt roll through the slot with the metal pin.
- The end of the belt should be fastened with the metal pin in the slot next to the slot where it entered the belt roll.
- The pin should be resting in the slot as much as possible. Pull the belt to make the pin fit in the slot.

The battery pack consists of two 12 V, 2.3 Ah, lead type batteries. The lifetime is up to 5 years depending on charging and usage.

Replacing the battery:

1. Follow the steps 1-6 in the “opening the lift chapter”.

Note! Make sure to remove the battery cable that connects to the circuit board (not the battery cables that is placed on the battery).

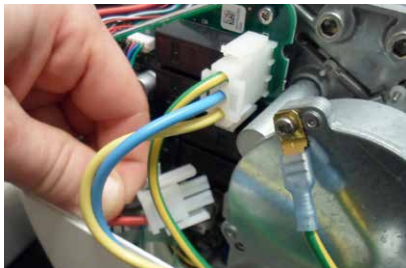

2. Unscrew the metal bracket from the chassis by using a 2,5 mm Allen key.

Warning! Do not remove the battery cables show in the picture below! They should stay on until the screw is loosened to avoid short circuit.



3. Now - disconnect the battery cables located on the battery.

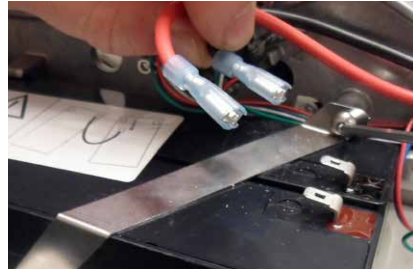

4. Lift up the battery pack from the lift.



5. When the batteries is removed from the lift, disconnect all four cables.

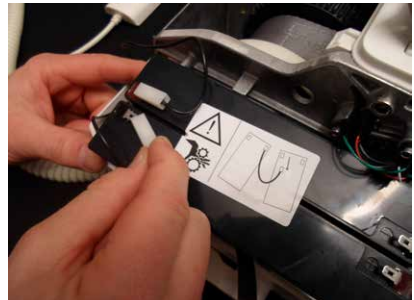

5. Fit the new batteries and re-connect the cables. Make sure the batteries are connected the same way as before. The batteries connectors from the circuit board and the battery terminals are color coded. Cables from emergency stop can be connected in any order.
6. Secure the battery cables between the battery (outside the steel brackets) and the lift cover.
7. Follow the steps 1-5 in reverse to complete the battery change.

Sprängskiss - Altair

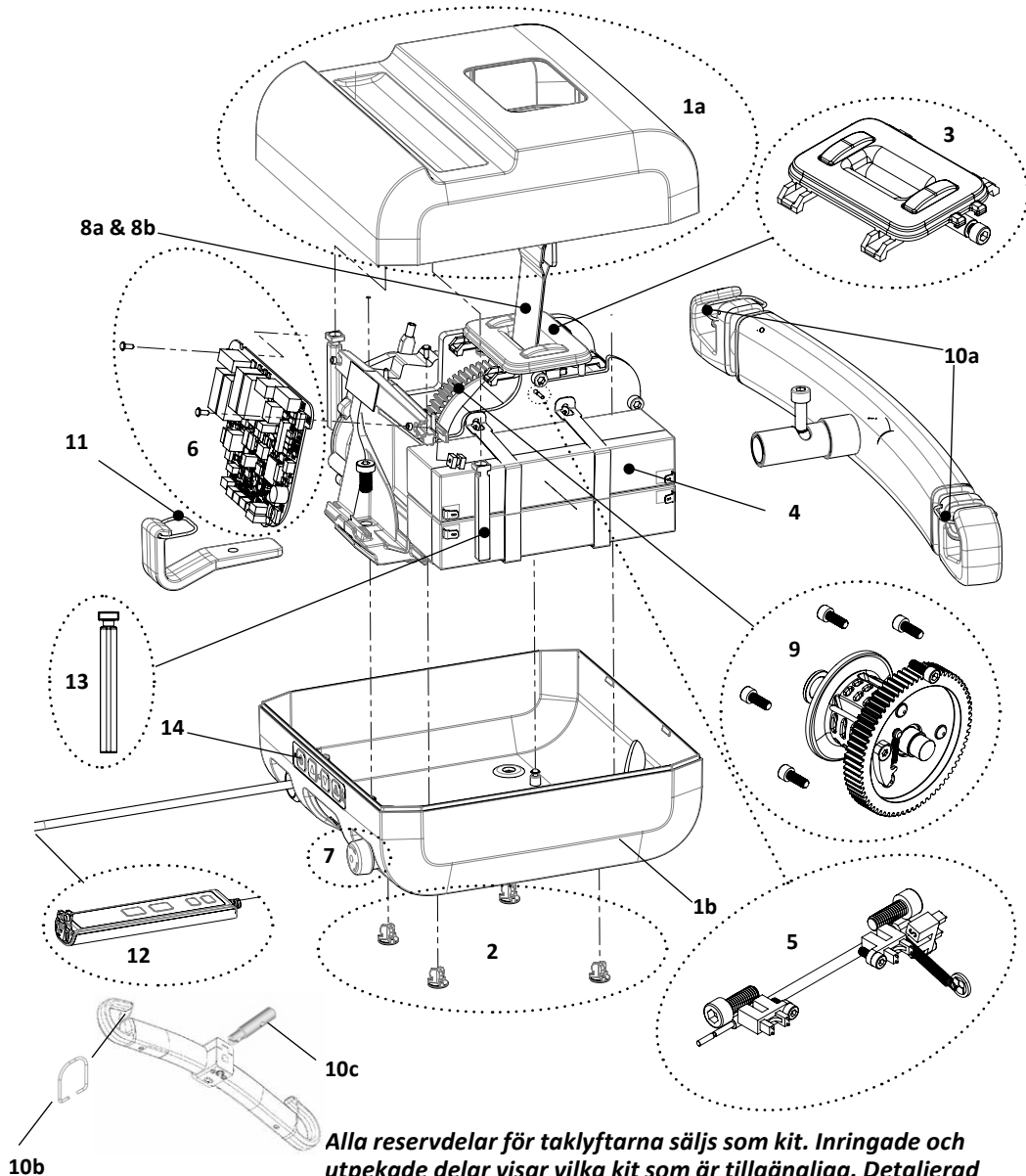

Alla reservdelar för taklyftarna säljs som kit. Inringade och utpekade delar visar vilka kit som är tillgängliga. Detaljerad lista med vad som ingår i varje kit visas på nästa sida.

Kitnummer i sprängskiss	Art. nr.	Reservdelskit	Inkluderat i kit	Antal delar i kit
1a	71461	Övre kåpa Altair - kit	Screw PT WN1452 K30x40 FZB	2
			Top cover Altair	1
1b	92937	Undre kåpa Altair - Kit	Cover 54027 Label at customer specification (picture of original label required)	1 1
2	71445	Fötter portabel lyft - kit	Foot portable lift	20
3	71463	Övre brytare Altair HeliQ - kit	Belt guide Altair HeliQ	1
			Belt stop switch	2
			Belt idler shaft	1
			Screw MC6S M6x16 A2	2
4	71449	Batteri taklyft - kit 2 st	CT2.3-12_Battery	2
			3M VHB 5930 Double sided adhesive tape	2
4	71450	Batteri taklyft - kit 10 st	CT2.3-12_Battery	10
			3M VHB 5930 Double sided adhesive tape	10
5	71466	Sensorer bandstyrning Altair HeliQ - kit	Beltstop sensor with 350 cable	2
			Belttension guard sensor 1	1
			Spring Belt Tension Guard	1
			Washer Plastic BTG	1
			Washer-LB-A-4816	1
			Belt tension guard shaft	1
			Screw MC6S M3x8 A2-70	3
			Screw MC6S M6x16 A2	2
6	71474	Kretskort Altair 150kg - kit	Printed circuit board main Altair 150kg	1
			Screw PT WN1451 K30x8 FZB	2
6	71475	Kretskort Altair 220kg - kit	Printed circuit board main Altair 220kg	1
			Screw PT WN1451 K30x8 FZB	2
6	71476	Kretskort Altair 300kg - kit	Printed circuit board main Altair 300kg	1
			Screw PT WN1451 K30x8 FZB	2
7	71489	Nödstopp portabel lyft - kit	Emergency Stop 16	1
8a	71483	Lyftband taklyft SWL 150kg och 220 kg- kit	Lyftband för Altair, Roomer S, HeliQ, med lyftlängd 2120 mm	1
8b	71494	Lyftband taklyft SWL 300 kg - kit	Lyftband för Altair, Roomer S, HeliQ, med lyftlängd 1720 mm	1
9	71467	Bandrulle Altair HeliQ - kit	Screw MC6S M6x16 A2	6
			Belt Roll Altair HeliQ	1

Kitnummer i sprängskiss	Art. nr.	Reservdelskit	Inkluderat i kit	Antal delar i kit
			Shaft Belt Roll Altair HeliQ	1
			Washer roll	1
10a	71455	Fjäder bygel taklyft - kit	Spring	10
10b	72803	Låsklämma bygel taklyft	Klämmor för byglar 72754, 72755, 72757, 55751, 55764, 92938	10
10c	92764	Skaft - bygel teleskopisk taklyft - kit	Skaft för byglar 72754, 72755, 72757, 55751, 55764, 92938	1
11	71456	Fjäder till benkrok portabel lyft - kit	Spring	5
ej i sprängskiss	92974	Fjäder till målad benkrok Roomer S Altair	Klämma för benkrok 92956	
12	71457	Handkontroll portabel lyft - kit	Hand control Altair Roomer S	1
			Strain Relief Clamp cc12	1
			Screw PT WN1452 K30x10 FZB	2
ej i sprängskiss	54437	Knappbatteri CR-1025_BN	Knappbatteri till huvudkretskort	1
13	71462	Screw holder Altair HeliQ - kit	Screw Holder	10
14	71813	Sekundär kontrolpanel Roomer S Altair HeliQ	Membranpanel Roomer S Altair HeliQ	
Ej i sprängskiss	71470	Laddare Europe, taklyft - kit	Battery Charger	1
			Charger Cable Europe	1
			Handcontrol holder	1
			Ring strap for holder	1
Ej i sprängskiss	71471	Laddare Storbritannien, taklyft - kit	Battery Charger	1
			Cable Charger Great Britain	1
			Handcontrol holder	1
			Ring strap for holder	1
Ej i sprängskiss	71472	Laddare Japan, taklyft - kit	Battery Charger	1
			Cable Charger Japan	1
			Handcontrol holder	1
			Ring strap for holder	1
Ej i sprängskiss	71473	Laddare Nordamerika, taklyft - kit	Battery Charger	1
			Cable Charger North America	1
			Handcontrol holder	1
			Ring strap for holder	1
Ej i sprängskiss	71491	Laddare Australien, taklyft - kit	Battery Charger	1
			Cable Charger Australia	1

Kitnummer i sprængskiss	Art. nr.	Reservdelskit	Inkluderat i kit	Antal delar i kit
			Handcontrol holder	1
			Ring strap for holder	1
Ej i sprængskiss	90407	Bättringsfärg RAL9016		1

1. Aktivera nödstoppet.



2. Vänd lyften försiktigt upp-och-ner. Var försiktig med bältstoppensorn.



3. Ta bort gummifötterna närmast benkroken.



4. Lossa de två skruvarna med en

torxskruvmejsel (TX10, cirka 6-7 varv tills skruvarna är lösa). Skruvarna finns i botten av hålen där gummifötterna sitter.



5. Vänd tillbaka lyften och ta bort kåpan genom att böja det lite framåt mot bygelns tills du hör ett "klick".

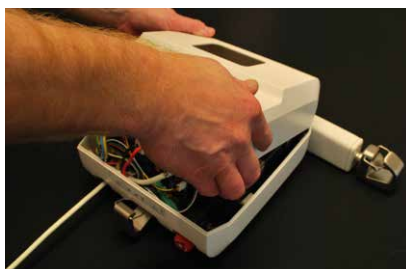

6. Ta alltid bort batterikabeln när du har öppnat kåpan/lyften.

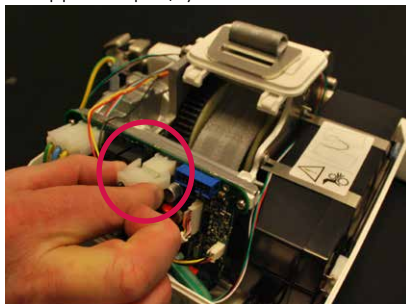

1. Se till att alla kablar är kopplade på samma sätt som när du öppnade lyften.
2. Se till att inga kablar är klämda mellan kåporna.
3. Följ steg 1-6 baklänges i kapitlet “öppna lyften”.

Glöm inte gummifötterna!

Glöm ej att sätta tillbaka alla kablar innan du stänger lyften!

Återställa servicealarm – Altair

När lyften är servad ska servicealarmet återställas.

- Anslut lyften till en dator genom “data- och serviceapplikationen”
- Klicka på service och logga in med dina inloggningsuppgifter.
- Klicka på “återställ servicealarm” enligt bilden till höger.



The screenshot shows the HUMAN CARE Data- och serviceapplikation interface. The top navigation bar includes 'START', 'ÖVERSIKT', 'STATISTIK', and 'SERVICE'. The 'SERVICE' tab is active. On the left sidebar, the 'ÅTERSTÄLL SERVICEALARM' button is highlighted with a red circle. The main content area shows service status: 'Senaste service' (2015-04-08) and 'Nästa servicebiljett' (2016-04-07). Below this is a 'FELRAPPORTER' table with columns for 'Datum', 'Tid', and 'Beskrivning'.

Datum	Tid	Beskrivning
2016-02-23	13:55	Nedbänkning i nödsituationer
2016-02-23	13:55	Nedbänkning i nödsituationer
2016-02-23	13:55	Nedbänkning i nödsituationer
2016-02-23	13:55	Nedbänkning i nödsituationer
2016-02-23	13:55	Nedbänkning i nödsituationer

Bältet kan bytas ut utan att bältesutgången behöver tas bort.

Följ steg 1-5 i kapitlet "öppna lyften".

1. Återaktivera nödstoppet.
2. Skruva loss Opto-Switchen och vrid den 90° för att fritt kunna använda lyften utan vikt.

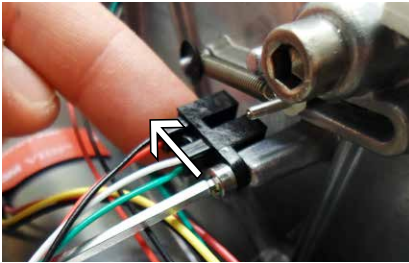

3. Dra ut bältet hela vägen ut från bältesrullen.

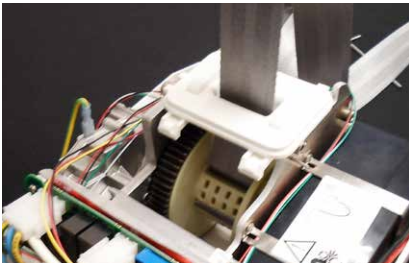

4. Skapa en stor ögla.



5. Använd till exempel en spackelspade för att skapa en ögla på andra sidan.

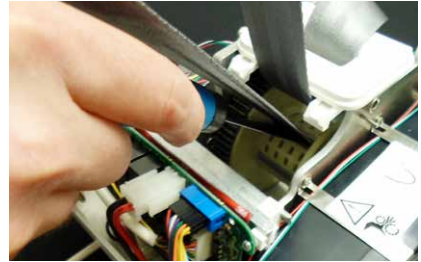

6. Tryck på uppknappen på handkontrollen för att vända bandrullen och ta tag i öglan.



7. Använd spackelspaden igen för att få ut änden av lyftbandet och ta ut sprinten.



8. Vänd bandrullen med uppknappen på handkontrollen och ta tag i bältet.

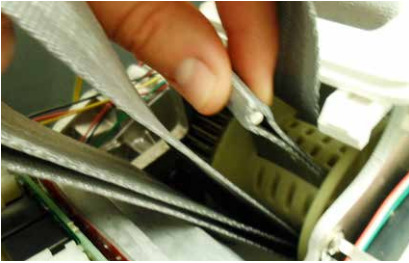

9. Ta bort sprinten, bältet är nu fritt att ta ut ur lyften.

10. För att sätta i det nya bältet i lyften, gör stegen i omvänd ordning.

Efter att det nya bältet är installerat, glöm ej att positionera opto-switchen till ursprunglig position!

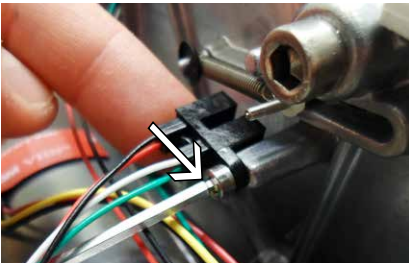

Batteripaketet består av 2 x 12V, 2,3 Ah, blytyp, monterade. Livslängden är upp till 5 år beroende på laddning och användning. Därefter måste batterierna bytas ut.

Byta ut batteriet:

1. Följ stegen 1-6 i kapitlet "öppna lyften".
2. Försök att inte förstöra varningsklistermärket på toppen av batteriet, till exempel genom att fälla upp ändarna.

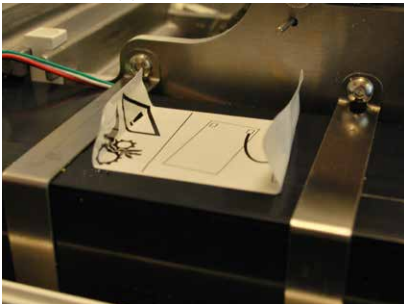

3. Skruva bort metallskruvarna genom att använda en 2,5 mm insexnyckel.

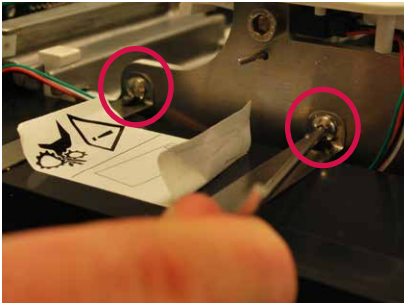

4. Lyft upp batteriet från lyften.

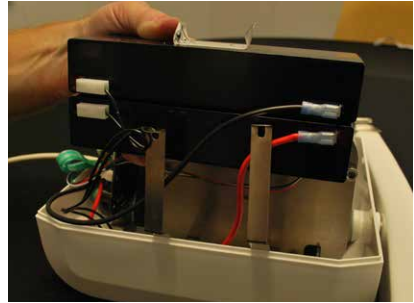

5. När batteriet är borttaget, ta bort alla fyra kablar.

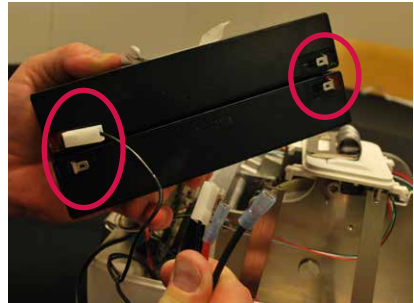

6. Sätt dit det nya batteriet på samma sätt som det var innan och sätt tillbaka alla kablar.

7. Säkra kablarna mellan batteriet och lyftkåpan.

8. Följ stegen 1-3 baklänges för att fullfölja batteribytet.

1. Följ stegen 1-6 i kapitlet "öppna lyften".
2. Ta bort handkontrollskabeln från kretskortet genom att trycka på det lilla plastlåset på vänster sida.

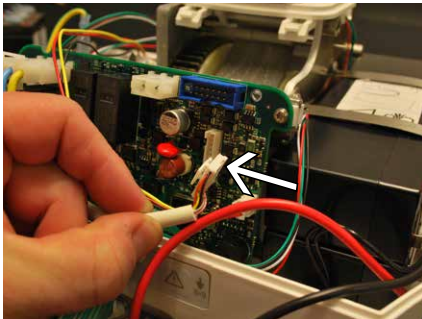

3. Ta bort de två skruvarna från kabelhållaren med en insexnyckel (10 mm, T10).

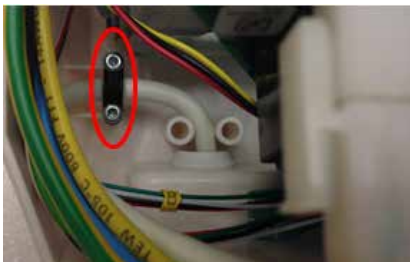
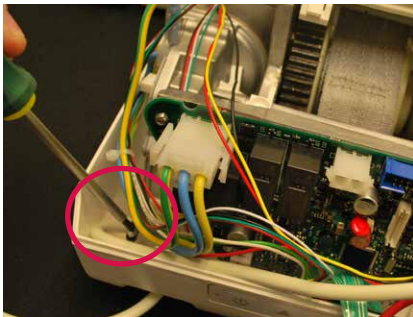

4. Ta bort gummiförseglingen från kåpan.

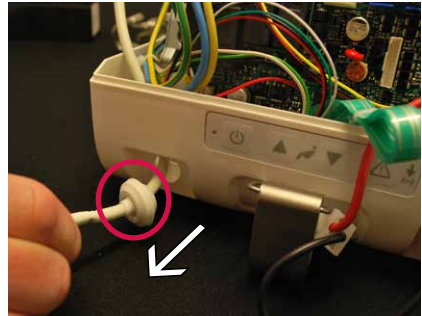

5. Dra ut kabeln genom hålet.

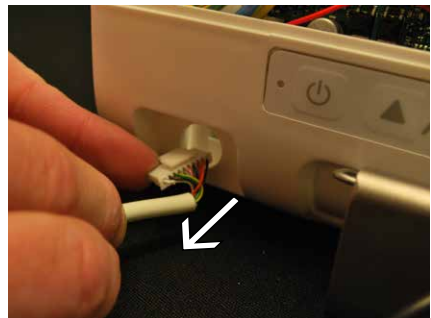

6. Följ alla stegen baklänges för att sätta dit den nya handkontrollen.

Om handkontrollen som ska bytas ut är trasig kan kabeln kapas för enklare hantering.

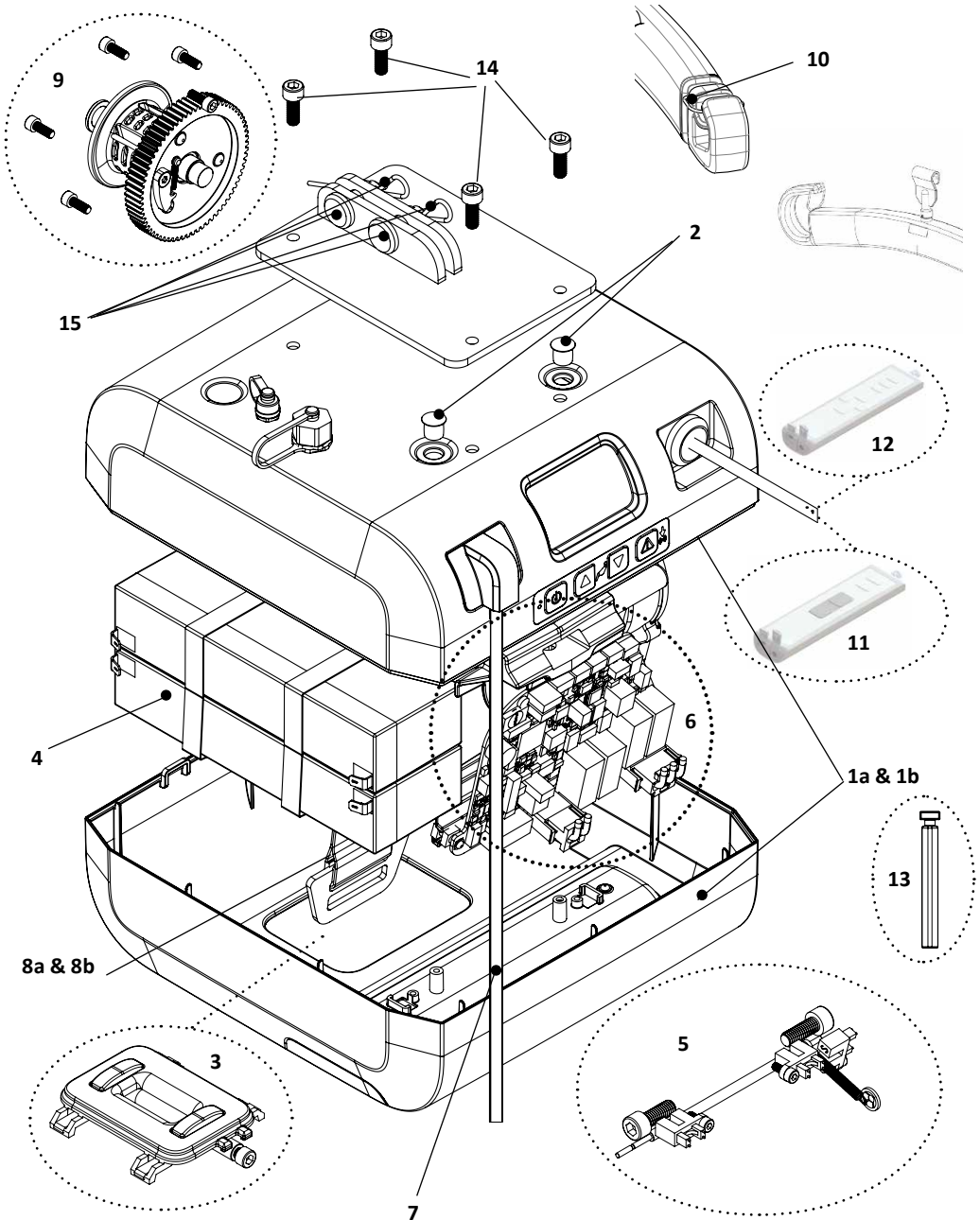

Alla reservdelar för taklyftarna säljs som kit. Inringade och utpekade delar visar vilka kit som är tillgängliga. Detaljerad lista med vad som ingår i varje kit visas på nästa sida.

Kitnummer i sprängskiss	Art. nr.	Reservdelskit	Inkluderat i kit	Antal delar i kit
1a	71464	Undre kåpa HeliQ - kit	Screw PT WN1452 K30x40 FZB	2
			Bottom cover	1
1b	92971	Övre kåpa HeliQ - kit	Kåpa 54028	1
			Label at customer specifications (picture of original label required)	1
2	71465	Täcklock HeliQ - kit	Cover Plug 9.3	20
3	71463	Övre brytare Altair HeliQ - kit	Belt guide Altair HeliQ	1
			Belt stop switch	2
			Belt idler shaft	1
			Screw MC6S M6x16 A2	2
4	71449	Batteri taklyft - kit 2 st	CT2.3-12_Battery	2
			3M VHB 5930 Double sided adhesive tape	2
4	71450	Batteri taklyft - kit 10 st	CT2.3-12_Battery	10
			3M VHB 5930 Double sided adhesive tape	10
5	71466	Sensorer bandstyrning Altair HeliQ - kit	Beltstop sensor with 350 cable	2
			Belttension guard sensor 1	1
			Spring Belt Tension Guard	1
			Washer Plastic BTG	1
			Washer-LB-A-4816	1
			Belt tension guard shaft	1
			Screw MC6S M3x8 A2-70	3
Screw MC6S M6x16 A2	2			
6	71477	Kretskort HeliQ 150kg - kit	Printed circuit board main HeliQ 150kg	1
			Screw PT WN1451 K30x8 FZB	2
6	71478	Kretskort HeliQ 220kg - kit	Printed circuit board main HeliQ 220kg	1
			Screw PT WN1451 K30x8 FZB	2
6	71479	Kretskort HeliQ 300kg - kit	Printed circuit board main HeliQ 300kg	1
			Screw PT WN1451 K30x8 FZB	2
7	71490	Nödstopp HeliQ - kit	Emergency Stop HeliQ	1
8a	71483	Lyftband taklyft SWL 150kg/220kg- kit	Lyftband till Altair Roomer S och HeliQ med lyftlängd 2120mm	1
8b	71494	Lyftband taklyft SWL 300kg	Lyftband till Altair Roomer S och HeliQ med lyftlängd 1720 mm	1

Kitnummer i sprängskiss	Art. nr.	Reservdelskit	Inkluderat i kit	Antal delar i kit
9	71467	Bandrulle Altair HeliQ - kit	Screw MC6S M6x16 A2	6
			Belt Roll Altair HeliQ	1
			Shaft Belt Roll Altair HeliQ	1
			Washer roll	1
10a	71455	Fjäder teleskopisk bygel taklyft - kit	Spring	10
10b	72803	Låsklämmor för bygel taklyft	Klämmor för byglar 72754, 72755, 72757, 55751, 55764, 92938	10
11	71458	Handkontroll HeliQ - kit	Hand control 4-button HeliQ	1
			Strain Relief Clamp cc12	1
			Screw PT WN1452 K30x10 FZB	2
ej i sprängskiss	54437	Knappbatteri CR-1025_BN	Knappbatteri till huvudkretskort	1
12	71459	Handkontroll HeliQ med åkmotor - kit	Hand control 7-button HeliQ power traverse	1
			Strain Relief Clamp cc12	1
			Screw PT WN1452 K30x10 FZB	2
13	71462	Skruvhållare Altair HeliQ - kit	Screw Holder	10
14	71468	Topplatta skruv HeliQ - kit	Screw MC6S M6x16 A2-70	20
15	71469	Sprint och låsnål HeliQ - kit	Locking needle	2
			Split pin CBH 20x25 fzb	2
Ej i sprängskiss	71470	Laddare Europa, taklyft - kit	Battery Charger	1
			Cable Charger Europe	1
			Handcontrol holder	1
			Ring strap for holder	1
Ej i sprängskiss	71471	Laddare Storbritannien, taklyft - kit	Battery Charger	1
			Cable Charger Great Britain	1
			Handcontrol holder	1
			Ring strap for holder	1
Ej i sprängskiss	71472	Laddare Japan, taklyft - kit	Battery Charger	1
			Cable Charger Japan	1
			Handcontrol holder	1
			Ring strap for holder	1
Ej i sprängskiss	71473	Laddare Nordamerika, taklyft - kit	Battery Charger	1
			Cable Charger North America	1
			Handcontrol holder	1
			Ring strap for holder	1

Kitnummer i sprängskiss	Art. nr.	Reservdelskit	Inkluderat i kit	Antal delar i kit
Ej i sprängskiss	71491	Laddare Australien, taklyft - kit	Battery Charger	1
			Cable Charger Australia	1
			Handcontrol holder	1
			Ring strap for holder	1
Ej i sprängskiss	90407	Bättringsfärg RAL9016		1
Ej i sprängskiss	92972	Sekundär kontrollpanel RoomerS, Altair, HeliQ	Membranpanel Roomer S, Altair, HeliQ	1

1. Aktivera nödstoppet.



2. Ta bort skruvarna på topplattan genom att använda en 5 mm insexnyckel. Ta bort topplattan.



3. Ta bort de två täcklocken.



4. Lossa de två skruvarna med en torxskruvmejsel (TX10, cirka 6-7 varv tills skruvarna är lösa).



5. Vänd tillbaka lyften och ta bort kåpan genom att böja det lite framåt mot motsatta sidan av kontrollpanelen tills du hör ett "klick".



6. Ta alltid bort batterikabeln när du har öppnat kåpan/lyften.

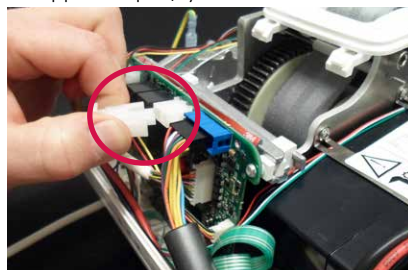

1. Se till att alla kablar är kopplade på samma sätt som när du öppnade lyften.
2. Se till att inga kablar är klämda mellan kåporna.
3. Följ steg 1-6 baklänges i kapitlet "öppna lyften".

Glöm inte plastpluggarna!

Glöm ej att sätta tillbaka alla kablar innan du stänger lyften!

Återställa servicealarm – HeliQ

När lyften är servad ska servicealarmet återställas.

- Anslut lyften till en dator genom "data- och serviceapplikationen"
- Klicka på service och logga in med dina inloggningsuppgifter.
- Klicka på "återställ servicealarm" enligt bilden till höger.



The screenshot shows the HUMAN CARE Data- och serviceapplikation interface. The top navigation bar includes 'START', 'ÖVERSIKT', 'STATISTIK', and 'SERVICE'. The 'SERVICE' tab is active. On the left sidebar, the 'ÅTERSTÄLL SERVICEALARM' button is highlighted with a red circle. Below it are 'UPPDATERA FIRMWARE' and 'STÄLL BY REALTIDSKLOCKA' buttons. The main content area shows service status: 'Senaste service' (2015-04-08) and 'Nästa serviceförelä' (2016-04-07). Below this is a 'FELRAPPORTER' table.

Datum	Tid	Beskrivning
2016-02-23	18:55	Nedsänkning i nödsituationer
2016-02-23	13:35	Nedsänkning i nödsituationer
2016-02-23	18:55	Nedsänkning i nödsituationer
2016-02-23	13:35	Nedsänkning i nödsituationer
2016-02-23	13:45	Nedsänkning i nödsituationer

Bältet kan bytas ut utan att bältesutgången behöver tas bort.

1. Följ steg 1-5 i kapitlet "öppna lyften".
2. Återaktivera nödstoppet.
3. Skruva loss Opto-Switchen och vrid den 90° för att fritt kunna använda lyften utan vikt.

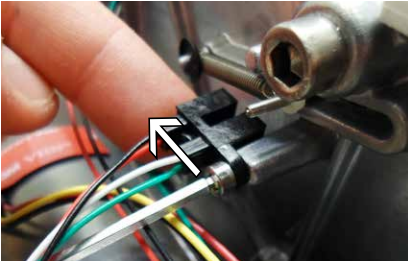

4. Dra ut bältet hela vägen ut från bältesrullen.

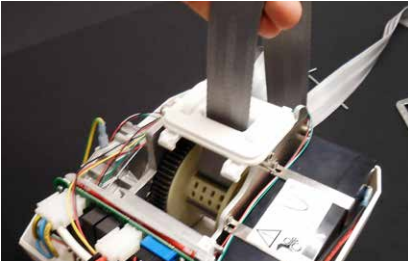

5. Skapa en stor ögla.



6. Använd till exempel en spackelspade för att skapa en ögla på andra sidan.

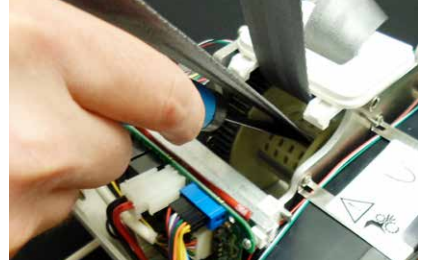

7. Tryck på uppknappen på handkontrollen för att vända bandrullen och ta tag i öglan.

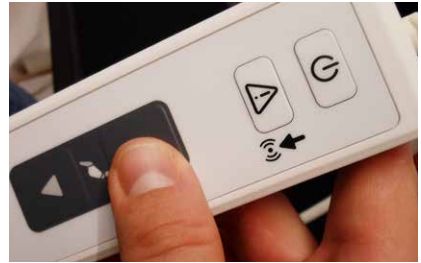

8. Använd spackelspaden igen för att få ut änden av lyftbandet och ta ut sprinten.



9. Vänd bandrullen med uppknappen på



10. Ta bort sprinten, bältet är nu fritt att ta ut ur lyften.

11. För att sätta i det nya bältet i lyften, gör stegen i omvänd ordning.

Efter att det nya bältet är installerat, glöm ej att positionera opto-switchen till ursprunglig position!

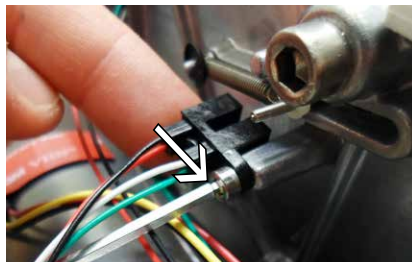

Batteripaketet består av 2 x 12V, 2,3 Ah, blytyp, monterade. Livslängden är upp till 5 år beroende på laddning och användning. Därefter måste batterierna bytas ut.

Byta ut batteriet:

1. Följ stegen 1-6 i kapitlet "öppna lyften".
2. Försök att inte förstöra varningsklistermärket på toppen av batteriet, till exempel genom att fälla upp ändarna.

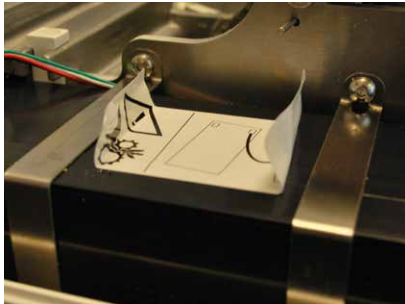

3. Skruva bort metallskruvarna genom att använda en 2,5 mm insexnyckel.

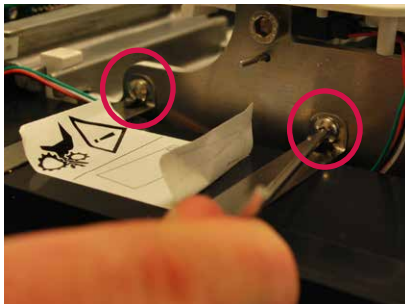

4. Lyft upp batteriet från lyften.

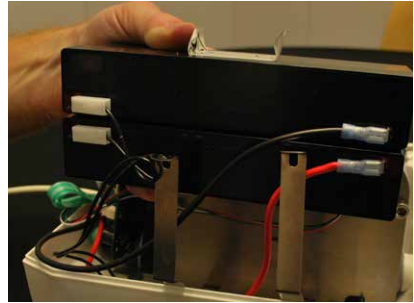

4. När batteriet är borttaget, ta bort alla fyra kablar.

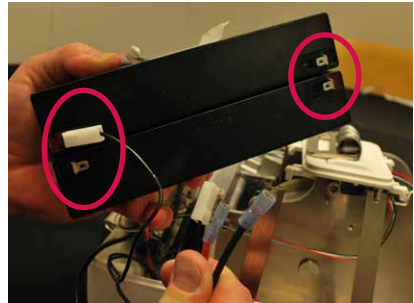

5. Sätt dit det nya batteriet på samma sätt som det var innan och sätt tillbaka alla kablar.

6. Säkra kablarna mellan batteriet och lyftkåpan.

7. Följ stegen 1-3 baklänges för att fullfölja batteribytet.

1. Följ stegen 1-6 i kapitlet "öppna lyften".
2. Ta bort handkontrollskabeln från kretskortet genom att trycka på det lilla plastlåset på vänster sida.

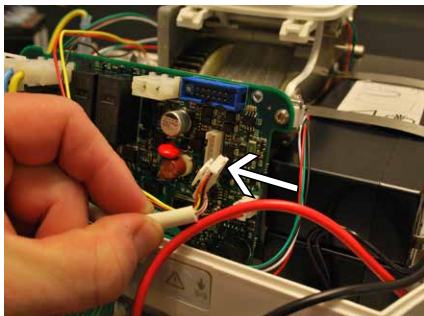

3. Ta bort de två skruvarna från kabelhållaren med en insexnyckel (10 mm, T10).

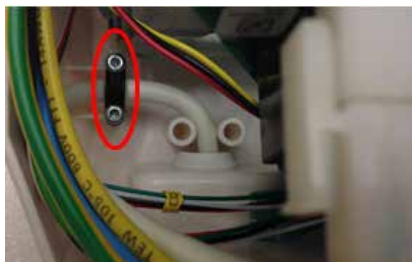
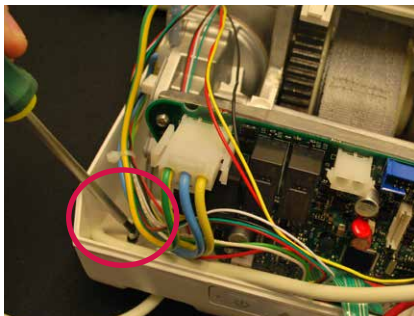

4. Ta bort gummiförseglingen från kåpan.

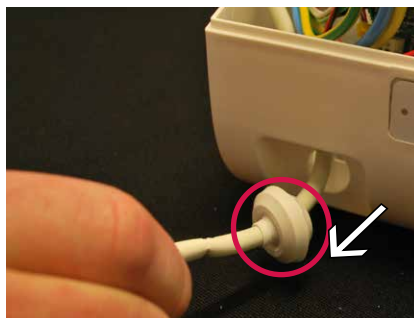

5. Dra ut kabeln genom hålet.

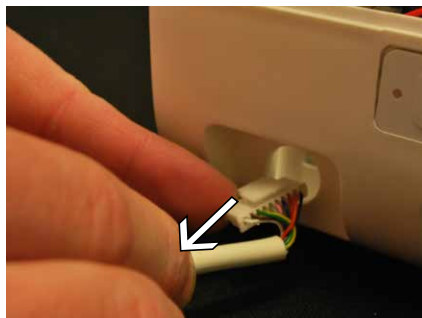

6. Följ alla stegen baklänges för att sätta dit den nya handkontrollen.

Om handkontrollen som ska bytas ut är trasig kan kabeln kapas för enklare hantering.

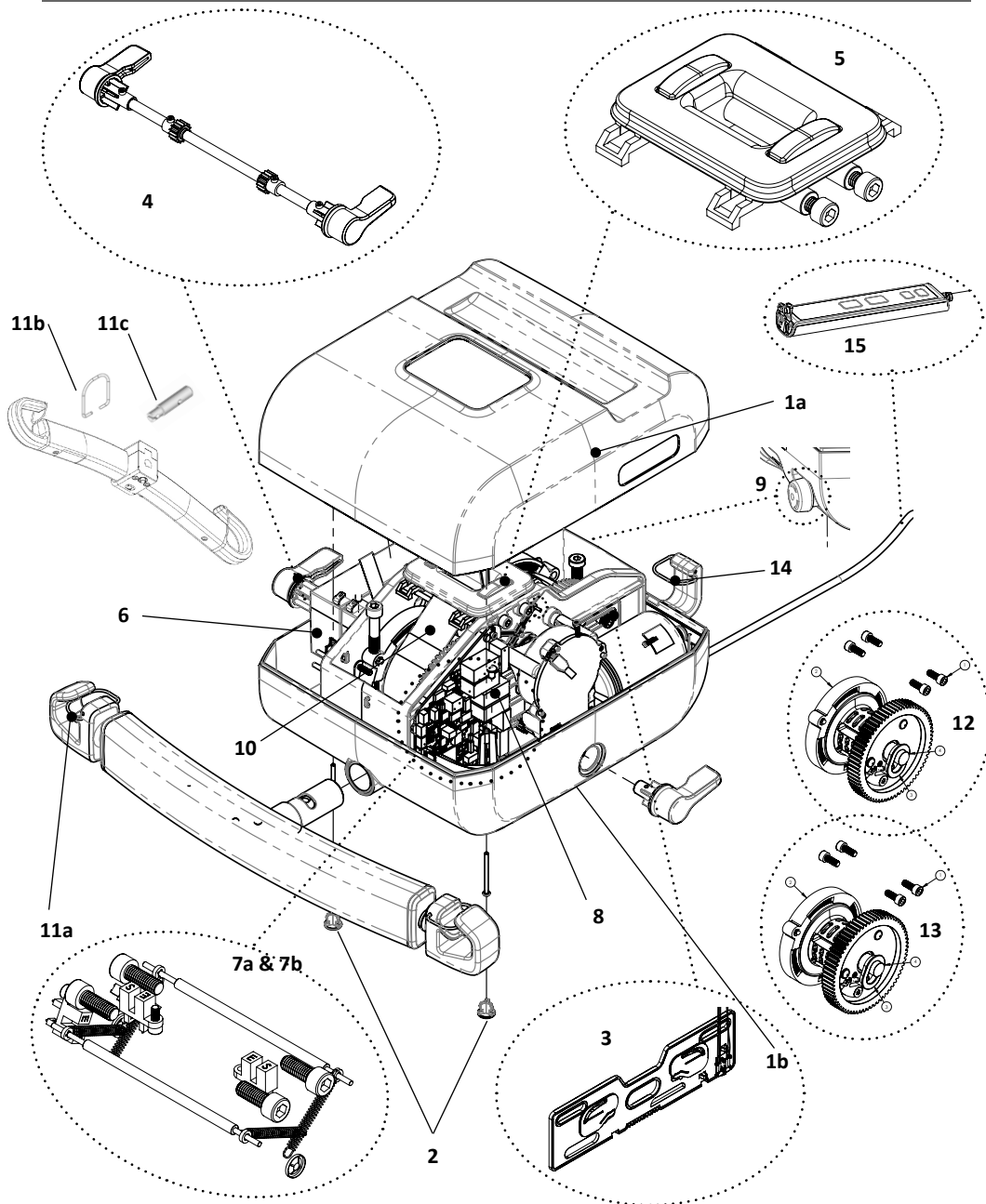

Alla reservdelar för taklyftarna säljs som kit. Inringade och utpekade delar visar vilka kit som är tillgängliga. Detaljerad lista med vad som ingår i varje kit visas på nästa sida.

Kitnummer i sprängskiss	Art. nr.	Reservdelskit	Inkluderat i kit	Antal delar i kit
1a	71460	Övre kåpa Roomer S - kit	Screw PT WN1452 K30x40 fzb	2
			Top cover Roomer S	1
1b	92936	Undre kåpa Roomer S kit	Kåpa 54055	1
			Etikett vid kundspecifikation (bild av original etikett nödvändig)	1
2	71445	Fötter portabel lyft - kit	Foot portable lift	20
3	71446	Glidplatta Roomer S - kit	Screw MC6LS M6x16	3
			Screw MC6S M6x16 A2	4
			Slider with sensor	2
4	71447	Spak Roomer S - kit	Roomer S switch lever	2
			Shaft Slider	1
			Screw MC6S M3x12 A2	4
			10015-N08 Mekanex	2
			Slide bearing 8x9x3	2
5	71448	Övre brytare Roomer S - kit	Belt guide Roomer S	1
			Belt stop switch Roomer S	2
			Belt idler shaft Roomer S	2
			Screw MC6S M6x16 A2	4
6	71449	Batteri taklyft - kit 2 st	CT2.3-12_Battery	2
			3M VHB 5930 Double sided adhesive tape	2
6	71450	Batteri taklyft - kit 10 st	CT2.3-12_Battery	10
			3M VHB 5930 Double sided adhesive tape	10
7	71451	Sensorer bandstyrning Roomer S - kit	Beltstop sensor with 350 cable	1
			Beltstop sensor with 400 cable	1
			Belttension guard sensor 2	1
			Belttension guard sensor 1	1
			Spring belt tension guard	4
			Washer Plastic BTG	4
			Washer-LB-A-4816	2
			Belt tension guard shaft	2
			Screw MC6S M3x8 A2-70	4
			Screw MC6S M6x16 A2	4
			Cable ties 2,5x100	3

Kitnummer i sprängskiss	Art. nr.	Reservdelskit	Inkluderat i kit	Antal delar i kit
8	71452	Kretskort Roomer S - kit	Printed circuit board main Roomer S 220 kg	1
			Screw MC6S M3x8 A2-70	3
9	71489	Nödstopp portabel lyft - kit	Emergency Stop 16	1
10a	71483	Lyftband taklyft SWL 150kg/220kg- kit	Lyftband till Altair Roomer S och HeliQ med lyftlängd 2120mm	1
10b	71494	Lyftband taklyft SWL 300kg	Lyftband till Altair, Roomer S och HeliQ med lyftlängd 1720mm	1
11a	71455	Fjäder teleskopisk bygel taklyft - kit	Spring	10
11b	72803	Låsklämmor för lyftbygel	Klämmor för lyftbygel 72754, 72755, 72757, 55751, 55764, 92938	1
11c	92764	Skaft - bygel teleskopisk taklyft - kit	För montering av lyftbygel 55751 och 55764	1
12	71453	Bandrulle medurs Roomer S - kit	Screw MC6S M6x16 A2	4
			Belt roll clock wise	1
			Bushing for belt roll shaft	2
			Shaft Belt Roll	1
13	71454	Bandrulle moturs Roomer S - kit	Screw MC6S M6x16 A2	4
			Belt roll counter clock wise	1
			Bushing for belt roll shaft	2
			Shaft Belt Roll	1
14	71456	Fjäder till benkrok portabel lyft - kit	Fjäder	5
ej i sprängskiss	92974	Fjäder till målad benkrok Roomer S Altair	Fjäder	
15	71457	Handkontroll portabel lyft - kit	Hand control portable lifts	1
			Strain Relief Clamp cc12	1
			Screw PT WN1452 K30x10 FZB	2
ej i sprängskiss	54437	Knappbatteri CR-1025_BN	Knappbatteri till huvudkretskort	
ej i sprängskiss	71470	Laddare Europa, taklyft - kit	Battery Charger	1
			Cable Charger Europe	1
			Handcontrol holder	1
			Ring strap for holder	1
ej i sprängskiss	71471	Laddare Storbritannien, taklyft - kit	Battery Charger	1
			Cable Charger Great Britain	1
			Handcontrol holder	1
			Ring strap for holder	1
	71472	Laddare Japan, taklyft - kit	Battery Charger	1

Kitnummer i sprängskiss	Art. nr.	Reservdelskit	Inkluderat i kit	Antal delar i kit
			Cable Charger Japan	1
			Handcontrol holder	1
			Ring strap for holder	1
ej i sprängskiss	71473	Laddare Nordamerika, taklyft - kit	Battery Charger	1
			Cable Charger North America	1
			Handcontrol holder	1
			Ring strap for holder	1
ej i sprängskiss	71491	Laddare Australien, taklyft - kit	Battery Charger	1
			Cable Charger Australia	1
			Handcontrol holder	1
			Ring strap for holder	1
ej i sprängskiss	90407	Bättringsfärg RAL9016		1
ej i sprängskiss	92972	Sekundär kontrollpanel RoomerS, Altair, HeliQ	Membran kontrolpanel RoomerS, Altair, HeliQ	
ej i sprängskiss	92973	Batterihållare kit		1
			54905 Batterihållare Roomer S	1
			55629 Heat shrink tubing	1

Öppna lyften - Roomer S

SV

1. Aktivera nödstoppet.



2. Vänd lyften försiktigt upp-och-ner. Var försiktig med beltstop-sensorn.



3. Ta bort gummfötterna närmast benkroken.



4. Lossa de två skruvarna med en torx, cirka 6-7 varv tills skruvarna är lösa. Skruvarna finns i botten av hålen där gummfötterna sitter.



5. Vänd tillbaka lyften och ta bort kåpan genom att böja det lite framåt mot benkroken tills du hör ett "klick".



6. Ta alltid bort batterikabeln när du har öppnat kåpan/lyften.

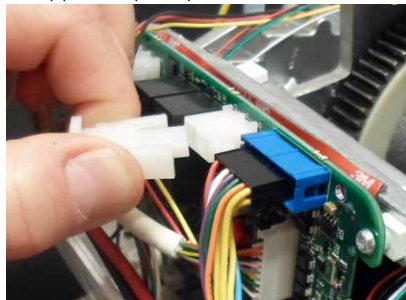

1. Se till att alla kablar är kopplade på samma sätt som när du öppnade lyften.
2. Se till att inga kablar är klämda mellan kåporna.
3. Följ steg 1-6 baklänges i kapitlet "öppna lyften".

Glöm inte gummifötterna!

Glöm ej att sätta tillbaka alla kablar innan du stänger lyften!

Återställa servicealarm – Roomer S

När lyften är servad ska servicealarmet återställas.

- Anslut lyften till en dator genom "data- och serviceapplikationen"
- Klicka på service och logga in med dina inloggningsuppgifter.
- Klicka på "återställ servicealarm" enligt bilden till höger.



The screenshot shows the 'HUMAN CARE Data- och serviceapplikation' interface. The top navigation bar includes 'START', 'ÖVERSIKT', 'STATISTIK', and 'SERVICE'. Below this, there are three main sections: 'ÅTERSTÄLL SERVICEALARM' (highlighted with a red circle), 'UPPDATERA FIRMWARE', and 'SÄLL IN REALTIDSKLOCKA'. The 'SERVICE' section displays 'Senaste service' (2015-04-08) and 'Nästa serviceöppnande' (2016-04-07). Below this is a 'FELRAPPORTER' table with columns for 'Datum', 'Tid', and 'Beskrivning'.

Datum	Tid	Beskrivning
2016-02-23	13:55	Neddränking i nödsituationer
2016-02-23	13:55	Neddränking i nödsituationer
2016-02-23	13:55	Neddränking i nödsituationer
2016-02-23	13:55	Neddränking i nödsituationer
2016-03-21	13:06	Neddränking i nödsituationer

1. Följ stegen 1-6 i kapitlet "öppna lyften".
2. Ta bort handkontrollskabeln från kretskortet genom att trycka på det lilla plastlåset på översidan.

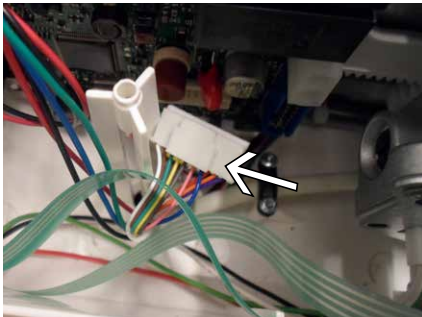
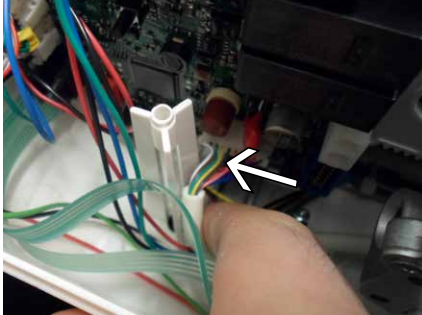

3. Ta bort gummiförseglingen från kåpan.



4. Använd till exempel en skruvmejsel för att "flippa" över kabeln till vänster likt bilden nedan.

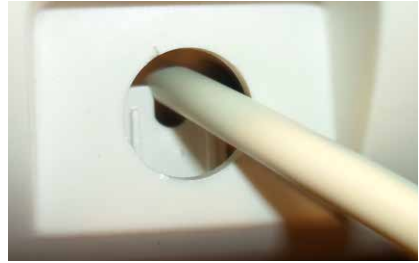

5. Dra ut kabeln genom hålet.

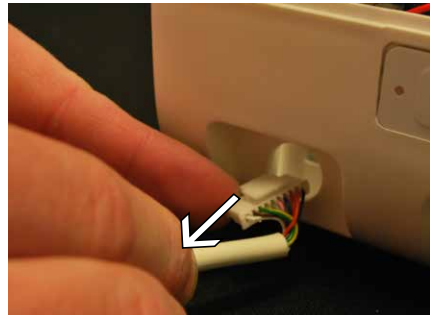

6. Följ alla stegen baklänges för att sätta dit den nya handkontrollen.

Om handkontrollen som ska bytas ut är trasig kan kabeln kapas för enklare hantering.

Bältet kan bytas ut utan att bältesutgången behöver tas bort.

1. Följ steg 1-5 i kapitlet "öppna lyften".
2. Dra ut det olåsta bältet hela vägen från bandrullen.

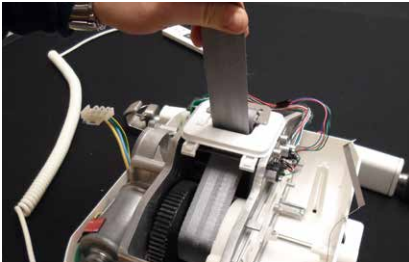

3. Skapa en stor ögla.

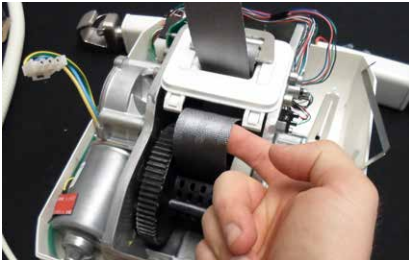

4. Använd till exempel en spackelspade för att skapa en ögla på andra sidan.

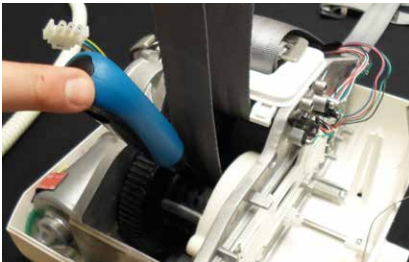

5. Använd handkontrollen eller spaken för att vända bältet och ta tag i öglan.



6. Använd spackelspaden igen för att få ut änden av lyftbandet och ta ut sprinten.



7. Vänd bandrullen igen och ta tag i bältet.



OBS! Vrid inte på roomerspaken utan att hålla i bandrullen eftersom det då kommer att rullas upp. Om du tappar bältet, snurra bältet 9,5 varv från bandrullen med en metallspint.

7. Ta bort sprinten, bältet är nu fritt att ta ut ur lyften.



8. Om du behöver byta ut även det andra bältet, gör likadant på motsatt sida.

9. För att sätta i det nya bältet i lyften, gör stegen i omvänd ordning.

OBS! Se till att den svarta etiketten på båda bältena är vända mot varandra.

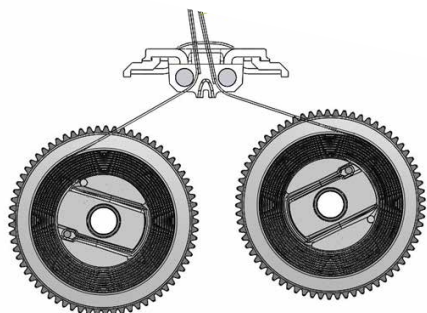

OBS! Kontrollera att bältena sitter på rätt sida av skyddet för bältespännaren.

- Bältet ska gå in i bältesrullen genom uttaget med metallsprinten.
- Slutet av bältet ska fästas med metallsprinten i uttaget bredvid det uttag där det gick in i bältesrullen.
- Sprinten ska vila så mycket som möjligt i uttaget. Dra i bältet för att kontrollera att sprinten passar i uttaget.

Batteripaketet består av två 12V, 2,3 Ah, blytyp, monterade. Livslängden är upp till 5 år beroende på laddning och användning.

Så här byter du ut batteriet:

1. Följ stegen 1-6 i kapitlet "öppna lyften".

OBS! Se till att ta bort batterikablarna som är kopplade till kretskortet (ej batterikablarna som är kopplade till batteriet)

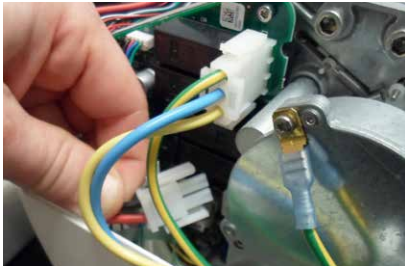

2. Skruva bort metallskruvarna genom att använda en 2,5 mm insexnyckel.

Varning! Ta ej bort batterikablarna som visas i bilden nedan! De ska vara ikopplade tills dess att skruvarna är lossade för att undvika kortslutning!



3. Ta bort batterikablarna som är placerade på batteriet.

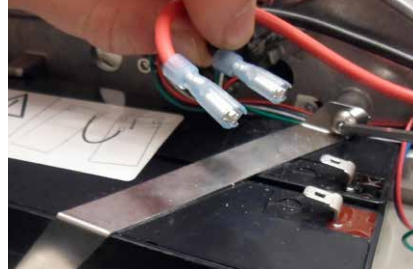

4. Lyft upp batteriet från lyften.



5. När batteriet är borttaget, ta bort alla fyra kablar.

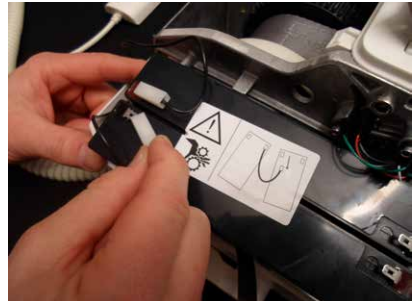

6. Sätt dit det nya batteriet på samma sätt som det var innan och sätt tillbaka alla kablar.
7. Säkra kablarna mellan batteriet och lyftkåpan.
8. Följ stegen 1-3 baklänges för att fullfölja batteribytet.

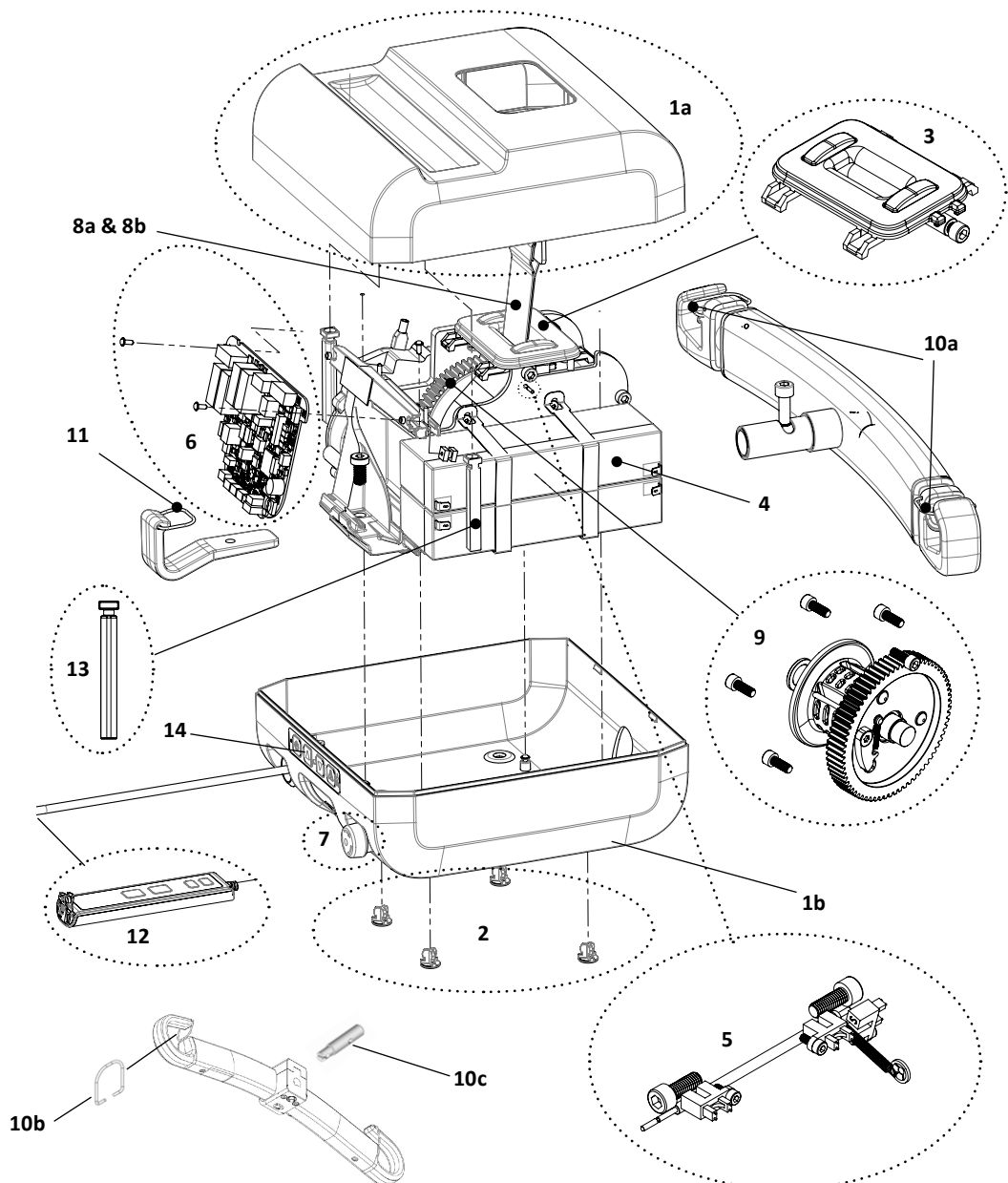

Tutti i pezzi di ricambio per i sollevatori a soffitto sono venduti come kit. Le parti evidenziate da un cerchio puntate mostrano i kit disponibili. L'elenco dettagliato con le parti incluse è riportato sulla pagina successiva.

Numero kit in vista esplosa	Parte n.	Kit parti di ricambio	Incluso nel kit	Quantità di pezzi nel kit
1a	71461	Coperchio superiore Altair - kit	Vite PT WN1452 K30x40 FZB	2
			Coperchio superiore Altair	1
1b	92937	Coperchio inferiore Altair	Coperchio 54027 Etichetta sulla specifica del cliente (è necessaria la figura dell'etichetta originale)	1
2	71445	Sollevatore a pedale portatile - kit	Sollevatore a pedale portatile	20
3	71463	Finecorsa superiore Altair HeliQ - kit	Guida nastro Altair HeliQ	1
			Interruttore di arresto nastro	2
			Ingranaggio folle albero del nastro	1
			Vite MCGS M6x16 A2	2
4	71449	Carroponte a batteria - kit	CT2.3-12_Batteria	2
			3M VHB 5930 Nastro biadesivo	2
4	71450	Sollevatore a soffitto a batteria - kit	CT2.3-12_Batteria	10
			3M VHB 5930 Nastro biadesivo	10
5	71466	Sensore arresto cinghia Altair HeliQ - kit	Sensore arresto cinghia con cavo 350	2
			Sensore protezione tendcinghia 1	1
			Protezione tensione cinghia a molla	1
			Rondella in plastica BTG	1
			Rondella-LB-A-4816	1
			Albero protezione tensione cinghia	1
			Vite MCGS M3x8 A2-70	3
			Vite MCGS M6x16 A2	2
6	71474	Scheda circuito Altair 150 kg - kit	Circuito stampato principale Altair 150 kg	1
			Vite PT WN1451 K30x8 FZB	2
			Rondella plastica 4,83x3,05x2,54	2
6	71475	Scheda circuito Altair 220 kg - kit	Circuito stampato principale Altair 220 kg	1
			Vite PT WN1451 K30x8 FZB	2
			Rondella plastica 4,83x3,05x2,54	2
6	71476	Scheda circuito Altair 300 kg - kit	Circuito stampato principale Altair 300 kg	1
			Vite PT WN1451 K30x8 FZB	2
			Rondella plastica 4,83x3,05x2,54	2
non nella vista	54437	Batteria a bottone CR-1025_BN	Batteria per circuito principale	1

Numero kit in vista esplosa	Parte n.	Kit parti di ricambio	Incluso nel kit	Quantità di pezzi nel kit
7	71489	Arresto di emergenza sollevatore portatile - kit	Arresto di emergenza 16	1
8a	71483	Cinghia di sollevamento a soffitto SWL 150kg/330lbs e 220kg/440lbs	Cinghia di sollevamento per Altair, Roomer S ed HeliQ con lunghezza di sollevamento 2120 mm	1
8b	71494	Cinghia di sollevamento a soffitto SWL 300 kg/660 lbs - kit	Cinghia di sollevamento per Altair, Roomer S ed HeliQ con lunghezza di sollevamento 1720 mm	1
9	71467	Rullo cinghia Altair HeliQ - kit	Vite MC6S M6x16 A2	6
			Rullo cinghia Altair HeliQ	1
			Albero rullo cinghia Altair HeliQ	1
			Rullo rondella	1
10a	71455	Barra di sospensione a molla sollevatore a soffitto - kit	Molla	10
10b	72803	Clip di bloccaggio per barra di sospensione	Clip per barre di sospensione 72754, 72755, 72757, 55751, 55764, 92938	10
10c	92764	Albero per barra di sospensione	Per il montaggio di barre di sospensione 755751, 55764	1
11	71456	Gancio in acciaio inox per Altair Roomer S - kit	Molla	5
non nella vista	92974	Molla rivestita per gancio Roomer S Altair	Clip per gancio 92956	5
12	71457	Comando manuale Altair Roomer S - kit	Comando manuale Altair Roomer S	1
			Morsetto pressacavo cc12	1
			Vite PT WN1452 K30x10 FZB	2
13	71462	Supporto a vite Altair HeliQ - kit	Supporto a vite	10
14	71813	Pannello di controllo secondario Roomer S Altair HeliQ	Pannello a membrana Roomer S Altair HeliQ	1
non nella vista	71470	Caricabatterie Europa sollevatore a soffitto - kit	Caricabatterie	1
			Cavo caricabatterie Europa	1
			Supporto per comando manuale	1
			Cinturino ad anello per supporto	1
non nella vista	71471	Caricabatterie Gran Bretagna, sollevatore a soffitto - kit	Caricabatterie	1
			Cavo caricabatterie Gran Bretagna	1
			Supporto per comando manuale	1
			Cinturino ad anello per supporto	1
non nella vista	71472	Caricabatterie Giappone, sollevatore a soffitto - kit	Caricabatterie	1
			Cavo caricabatterie Giappone	1
			Supporto per comando manuale	1

Numero kit in vista esplosa	Parte n.	Kit parti di ricambio	Incluso nel kit	Quantità di pezzi nel kit
			Cinturino ad anello per supporto	1
non nella vista	71473	Caricabatterie Nord America, sollevatore a soffitto - kit	Caricabatterie	1
			Cavo caricabatteria Nord America	1
			Supporto per comando manuale	1
			Cinturino ad anello per supporto	1
non nella vista	71491	Caricabatterie Australia, sollevatore a soffitto - kit	Caricabatterie	1
			Cavo caricabatterie Australia	1
			Supporto per comando manuale	1
			Cinturino ad anello per supporto	1
non nella vista	90407	Miglioramento del colore RAL9016		1
non nella vista	71811	Kit vite di copertura 10 pz.	Vite di copertura	10
non nella vista	92972	Pannello di controllo secondario RoomerS Altair HeliQ	Pannello a membrana RoomerS Altair HeliQ	1

1. Attivare l'arresto di emergenza.



2. Capovolgere il sollevatore. Fare attenzione ai sensori di arresto della cinghia.



3. Rimuovere i piedini in gomma più vicini al gancio per le gambe del sollevatore Altair.



4. Svitare le due viti con un cacciavite torsionometrico (TX10) tenendo insieme i coperchi (circa 6-7 giri o finché non si allenta). Le viti si trovano nella parte inferiore dei fori per i piedini in gomma/plastica.



5. Ruotare il sollevatore e rimuovere il coperchio inclinandolo leggermente verso la barra di sospensione fino a sentire "clac".

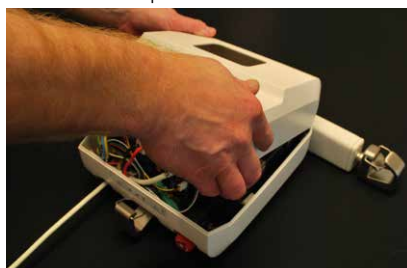

6. Scollegare sempre il cavo della batteria quando il coperchio è aperto.

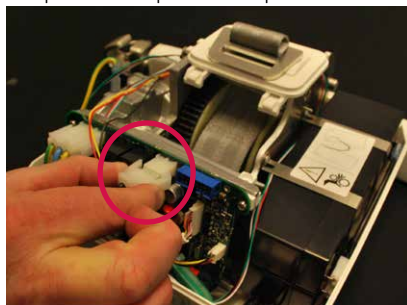

1. Assicurarsi che tutti i cavi siano collegati come erano quando il sollevatore è stato aperto.
2. Assicurarsi che nessun cavo sia stato schiacciato tra i coperchi.
3. Seguire i passaggi da 1 a 6 nel capitolo “Apertura del sollevatore” in ordine inverso.

Non dimenticare i piedini in gomma!

Ricordarsi di collegare tutti i cavi prima di chiudere il sollevatore!

Ripristino dell’allarme di manutenzione — Altair

Al termine della manutenzione bisogna ripristinare l’allarme di manutenzione.

- Collegare il sollevatore al computer tramite “Applicazione dati e manutenzione”. Nel software, cliccare su manutenzione e accedere con le credenziali di accesso. Fare clic sul pulsante “Ripristino allarme manutenzione”.

The screenshot shows the 'HUMAN CARE Data- och serviceapplikation' interface. The top navigation bar includes 'START', 'ÖVERSIKT', 'STATISTIK', and 'SERVICE'. Below this, there are three main sections: 'ÅTERSTÄLL SERVICEALARM' (circled in red), 'UPPDATERA FIRMWARE', and 'STÄLL IN REALTIDSKLOCKA'. The 'SERVICE' section displays a table with columns for 'Senaste service' and 'Nästa serviceöfille'. The 'FELRAPPORTER' section displays a table with columns for 'Datum', 'Tid', and 'Beskrivning'.

Senaste service	Nästa serviceöfille
2015-04-08	2016-04-07

Datum	Tid	Beskrivning
2016-02-23	13:55	Nedbänkning i nödsituationer
2016-02-23	13:55	Nedbänkning i nödsituationer
2016-02-23	13:55	Nedbänkning i nödsituationer
2016-02-23	13:55	Nedbänkning i nödsituationer
2016-02-23	13:55	Nedbänkning i nödsituationer

La cinghia può essere sostituita senza smontare l'uscita della cinghia.

Seguire i passaggi da 1 a 5 nel capitolo "Apertura del sollevatore".

1. Riattivare l'arresto di emergenza.
2. Svitare l'interruttore Opto della protezione della tensione della cinghia e ruotarlo di 90° per poter azionare liberamente il sollevatore senza peso.

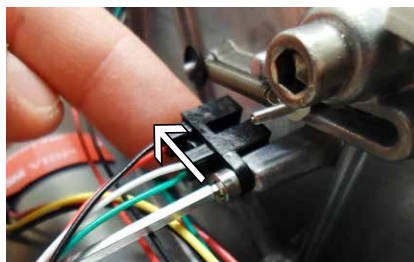

3. Trascinare la cinghia fino in fondo dal rullo cinghia.

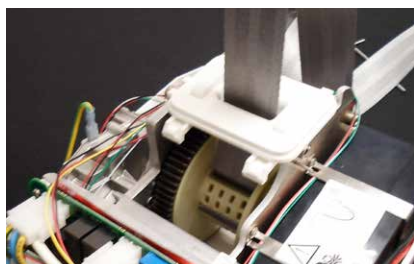

4. Crea una grande ansa.



5. Usare ad esempio una spatola per creare un'ansa sull'altro lato.

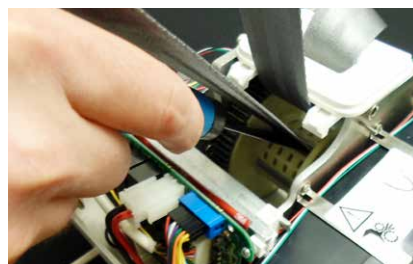

6. Premere il pulsante "su" sul comando manuale per ruotare il rullo della cinghia e afferrare l'ansa.



7. Usare di nuovo la spatola per estrarre l'estremità della cinghia con il piccolo perno.



8. Riportare il rullo della cinghia con il pulsante su sul comando manuale. Afferrare la cinghia.



9. Rimuovere il perno, la cinghia è ora allentata.

10. Per inserire la nuova cinghia, eseguire i passaggi in ordine inverso.

***Dopo aver assemblato la nuova cinghia.
Assicurarsi di posizionare l'interruttore
Opto nella sua posizione di partenza!***

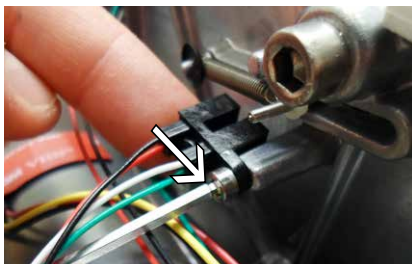

Il pacco batteria è composto da due batterie al piombo da 12 V, 2,3 Ah. La vita di servizio è di 5 anni a seconda della ricarica e dell'utilizzo.

Sostituzione della batteria:

1. Seguire i passaggi da 1 a 6 nel capitolo "Apertura del sollevatore".
2. Cerca di non danneggiare l'etichetta di avvertenza sulla parte superiore della batteria, ad esempio piegando le estremità dell'etichetta.

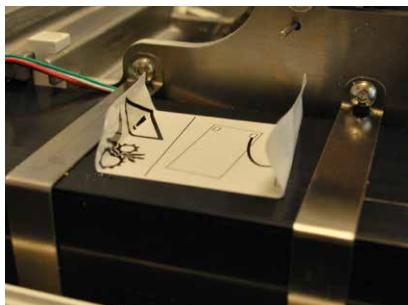

3. Svitare le due staffe metalliche dal telaio utilizzando una chiave a brugola da 2,5 mm.

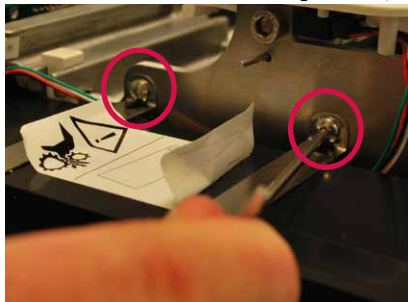

4. Sollevare il pacco batteria dal sollevatore.

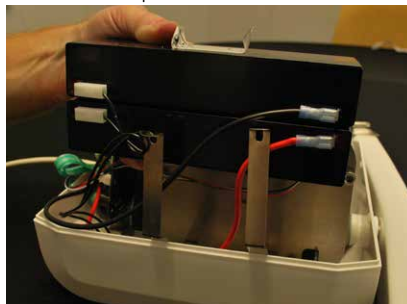

5. Quando le batterie vengono rimosse dal sollevatore, scollegare tutti e quattro i cavi.

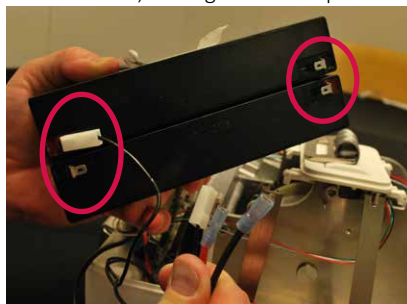

6. Inserire le nuove batterie e ricollegare i cavi. Assicurarsi che le batterie siano collegate allo stesso modo di prima del cambio.
7. Fissare i cavi tra la batteria (all'esterno delle staffe in acciaio) e il coperchio del sollevatore.
8. Seguire i passaggi da 1 a 3 in ordine inverso per completare la sostituzione della batteria.

1. Seguire i passaggi da 1 a 6 nel capitolo "Apertura del sollevatore".
2. Rimuovere il connettore sul cavo di comando manuale dal circuito stampato (PCB) premendo il piccolo lucchetto di plastica sul lato sinistro.

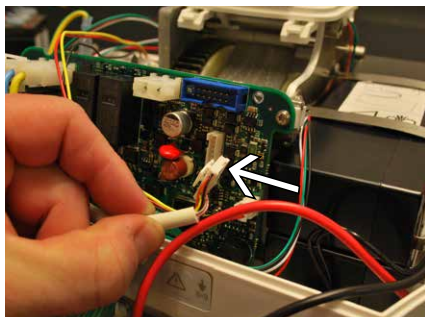

3. Rimuovere le due viti dal supporto del cavo con un cacciavite torsiometrico da 10 mm (T10).

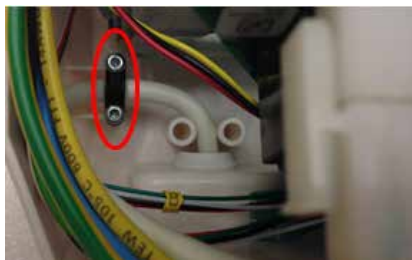
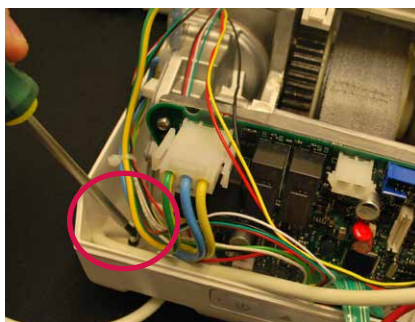

4. Rimuovere la guarnizione in gomma dal coperchio.

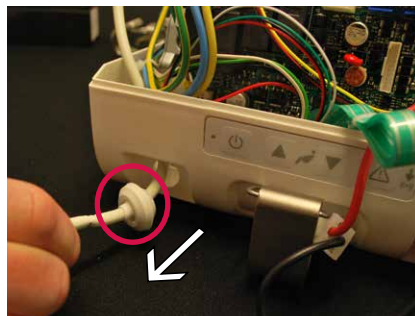

5. Estrarre il cavo e il connettore attraverso il foro.

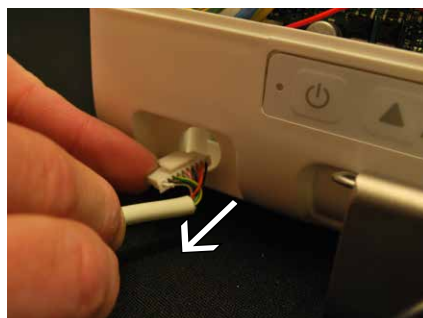

6. Ripetere i passaggi in ordine inverso per collegare il nuovo comando manuale.

Se il comando manuale è danneggiato/rotto, il cavo può essere tagliato per facilitare la rimozione del cavo.

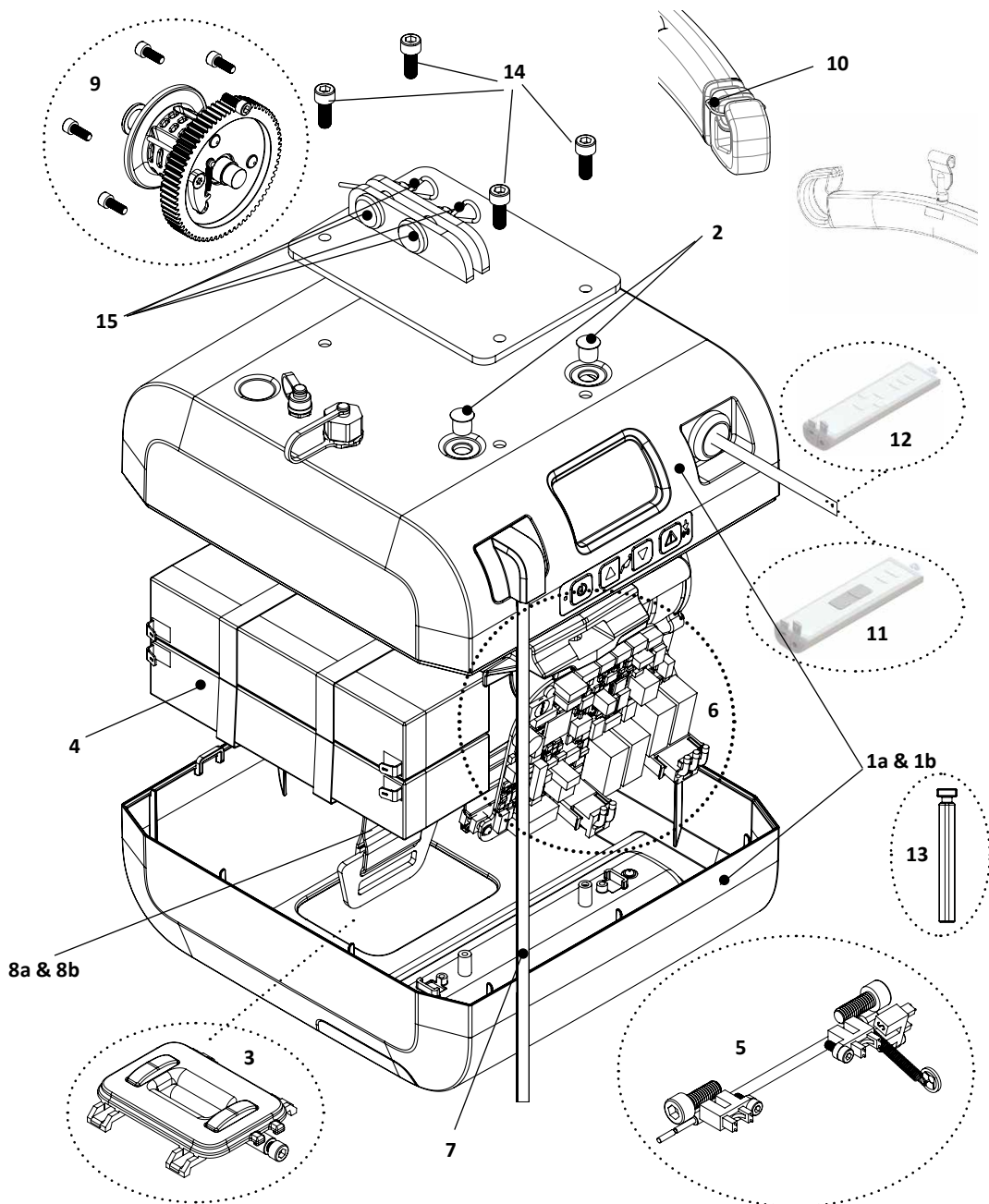

Tutti i pezzi di ricambio per i sollevatori a soffitto sono venduti come kit. Le parti evidenziate da un cerchio puntate mostrano i kit disponibili. L'elenco dettagliato con le parti incluse è riportato sulla pagina successiva.

Kit di ricambio - HeliQ



Numero kit in vista esplosa	Parte n.	Kit parti di ricambio	Incluso nel kit	Quantità di pezzi nel kit
1a	71464	Coperchio inferiore HeliQ - kit	Vite PT WN1452 K30x40 FZB	2
			Coperchio inferiore	1
1b	92971	Coperchio superiore HeliQ	Coperchio 54028	1
			Etichetta sulle specifiche del cliente (è necessaria la figura dell'etichetta originale)	1
2	71465	Tappo di copertura HeliQ - kit	Vite di copertura 9.3	20
3	71463	Fincorsa superiore Altair HeliQ - kit	Guida cinghia Altair HeliQ	1
			Interruttore di arresto cinghia	2
			Albero tendicinghia	1
			Vite MC6S M6x16 A2	2
4	71449	Sollevatore a soffitto a batteria - kit	CT2.3-12_Batteria	2
			3M VHB 5930 Nastro biadesivo	2
4	71450	Sollevatore a soffitto a batteria - kit	CT2.3-12_Batteria	10
			3M VHB 5930 Nastro biadesivo	10
5	71466	Sensore arresto cinghia Altair HeliQ - kit	Sensore arresto cinghia con cavo 350	2
			Sensore protezione tendicinghia 1	1
			Protezione tensione cinghia a molla	1
			Rondella in plastica BTG	1
			Rondella-LB-A-4816	1
			Albero protezione tensione cinghia	1
			Vite MC6S M3x8 A2-70	3
			Vite MC6S M6x16 A2	2
			Scorricinghia 1 pz.	1
			6	71477
Vite PT WN1451 K30x8 FZB	2			
Rondella plastica 4,83x3,05x2,54	2			
6	71478	Scheda circuito HeliQ 220 kg - kit	Circuito stampato principale HeliQ 220 kg	1
			Vite PT WN1451 K30x8 FZB	2
			Rondella plastica 4,83x3,05x2,54	2
6	71479	Scheda circuito HeliQ 300 kg - kit	Circuito stampato principale HeliQ 300 kg	1
			Vite PT WN1451 K30x8 FZB	2
			Rondella plastica 4,83x3,05x2,54	2
non nella vista	54437	Batteria a bottone CR-1025_BN	Batteria a bottone per circuito principale	2

Numero kit in vista esplosa	Parte n.	Kit parti di ricambio	Incluso nel kit	Quantità di pezzi nel kit
7	71490	Arresto di emergenza HeliQ - kit	Arresto di emergenza HeliQ	1
8a	71483	Cinghia di sollevamento a soffitto SWL 150 kg / 33 0lbs e 220 kg / 440 lbs	Cinghia di sollevamento per Altair, Roomer S ed HeliQ con lunghezza di sollevamento 2120 mm	1
8b	71494	Cinghia di sollevamento a soffitto SWL 300 kg/660 lbs - kit	Cinghia di sollevamento per Altair, Roomer S ed HeliQ con lunghezza di sollevamento 1720 mm	1
9	71467	Rullo cinghia Altair HeliQ - kit	Vite MC6S M6x16 A2	6
			Rullo cinghia Altair HeliQ	1
			Albero rullo cinghia Altair HeliQ	1
			Rullo rondella	1
10a	71455	Barra di sospensione a molla sollevatore a soffitto - kit	Molla	10
10b	72803	Clip di bloccaggio per barra di sospensione	Clip per barre di sospensione 72754, 72755, 72757, 55751, 55764, 92938	10
11	71458	Comando manuale HeliQ - kit	Comando manuale a 4 pulsanti HeliQ	1
			Morsetto pressacavo cc12	1
			Vite PT WN1452 K30x10 FZB	2
12	71459	Traversa alimentazione comando manuale HeliQ - kit	Traversa alimentazione comando manuale a 7 pulsanti HeliQ	1
			Morsetto pressacavo cc12	1
			Vite PT WN1452 K30x10 FZB	2
13	71462	Supporto a vite Altair HeliQ - kit	Supporto a vite	10
14	71468	Vite piastra superiore HeliQ - kit	Vite MC6S M6x16 A2-70	20
15	71469	Perno e perno di bloccaggio HeliQ - kit	Ago di bloccaggio	2
			Copiglia CBH 20x25 fzb	2
non nella vista	71470	Caricabatterie Europa sollevatore a soffitto - kit	Caricabatterie	1
			Cavo caricabatterie Europa	1
			Supporto per comando manuale	1
			Cinturino ad anello per supporto	1
non nella vista	71471	Caricabatterie Gran Bretagna, sollevatore a soffitto - kit	Caricabatterie	1
			Cavo caricabatterie Gran Bretagna	1
			Supporto per comando manuale	1
			Cinturino ad anello per supporto	1
non nella vista	71472	Caricabatterie Giappone, sollevatore a soffitto - kit	Caricabatterie	1
			Cavo caricabatterie Giappone	1
			Supporto per comando manuale	1
			Cinturino ad anello per supporto	1
non nella vista	71473	Caricabatterie Nord America, sollevatore a soffitto - kit	Caricabatterie	1
			Cavo caricabatteria Nord America	1
			Supporto per comando manuale	1
			Cinturino ad anello per supporto	1

Numero kit in vista esplosa	Parte n.	Kit parti di ricambio	Incluso nel kit	Quantità di pezzi nel kit
non nella vista	71491	Caricabatterie Australia, sollevatore a soffitto - kit	Caricabatterie	1
			Cavo caricabatterie Australia	1
			Supporto per comando manuale	1
			Cinturino ad anello per supporto	1
non nella vista	90407	Miglioramento del colore RAL9016		1
non nella vista	71811	Kit viti del coperchio	Vite del coperchio	10
non nella vista	92972	Pannello di controllo secondario Roomer S, Altair, HeliQ	Pannello a membrana Roomer S, Altair, HeliQ	1

1. Attivare l'arresto di emergenza.



2. Rimuovere le viti della piastra superiore utilizzando una chiave a brugola da 5 mm. Rimuovere la piastra superiore.



3. Rimuovere i due tappi di copertura.



4. Svitare le due viti con un cacciavite torsiometrico (TX10) tenendo insieme i coperchi.



5. Ruotare il sollevatore e rimuovere il coperchio inclinandolo leggermente verso il lato opposto del pannello di comando fino a sentire "clac".



6. Scollegare sempre il cavo della batteria quando il coperchio è aperto.

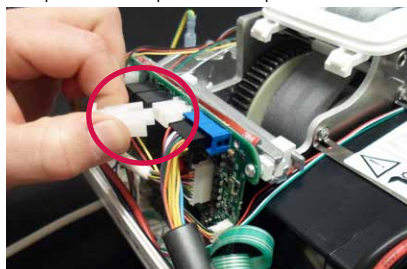

1. Assicurarsi che tutti i cavi siano collegati come erano quando il sollevatore è stato aperto.
2. Assicurarsi che nessun cavo sia stato schiacciato tra i coperchi.
3. Seguire i passaggi da 1 a 6 nel capitolo “Apertura del sollevatore” in ordine inverso.

Non dimenticare i tappi di copertura!

Ricordarsi di collegare tutti i cavi prima di chiudere il sollevatore!

Ripristino dell'allarme di manutenzione — HeliQ

Al termine della manutenzione bisogna ripristinare l'allarme di manutenzione.

- Collegare il sollevatore al computer tramite “Applicazione dati e manutenzione”. Nel software, cliccare su manutenzione e accedere con le credenziali di accesso. Fare clic sul pulsante “Ripristino allarme manutenzione”.

The screenshot shows the 'HUMAN CARE Data- och serviceapplikation' interface. The top navigation bar includes 'START', 'ÖVERSIKT', 'STATISTIK', and 'SERVICE'. Below this, there are three main sections: 'ÅTERSTÄLL SERVICEALARM' (highlighted with a red circle), 'UPPDATERA FIRMWARE', and 'STÄLL IN REALTIDSKLOCKA'. The 'SERVICE' section displays a table with columns for 'Senaste service' and 'Nästa serviceStälle'. The 'FELRAPPORTER' section displays a table with columns for 'Datum', 'Tid', and 'Beskrivning'.

Senaste service	Nästa serviceStälle
2015-04-08	2016-04-07

Datum	Tid	Beskrivning
2016-02-23	13:55	Nedsläckning i nödsituationer
2016-02-23	13:55	Nedsläckning i nödsituationer
2016-02-23	13:55	Nedsläckning i nödsituationer
2016-03-23	13:55	Nedsläckning i nödsituationer
2016-03-23	13:55	Nedsläckning i nödsituationer

La cinghia può essere sostituita senza smontare l'uscita della cinghia.

Seguire i passaggi da 1 a 5 nel capitolo "Apertura del sollevatore".

1. Riattivare l'arresto di emergenza.
2. Svitare l'interruttore Opto della protezione della tensione della cinghia e ruotarlo di 90° per poter azionare liberamente il sollevatore senza peso.

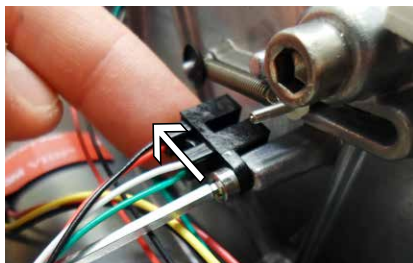

3. Trascinare la cinghia fino in fondo dal rullo cinghia.

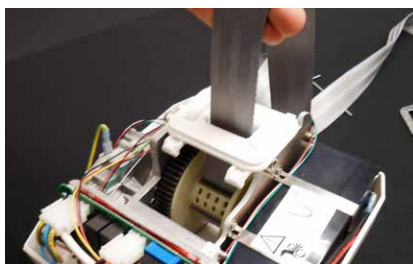

4. Crea una grande ansa.



5. Usare ad esempio una spatola per creare un'ansa sull'altro lato.

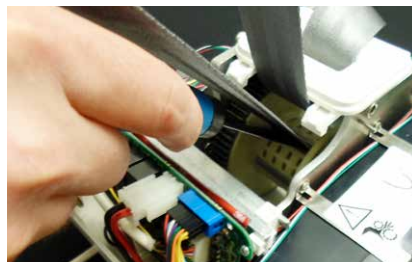

6. Premere il pulsante "su" sul comando manuale per ruotare il rullo della cinghia e afferrare l'ansa.



7. Usare di nuovo la spatola per estrarre l'estremità della cinghia con il piccolo perno.



8. Riportare il rotolo della cinghia con l'aiuto del comando manuale (pulsante su). Afferrare la cinghia.



9. Rimuovere il perno, la cinghia è ora allentata.

10. Per inserire la nuova cinghia, eseguire i passaggi in ordine inverso.

Dopo aver assemblato la nuova cinghia. Assicurarsi di posizionare l'interruttore Opto nella sua posizione di partenza!

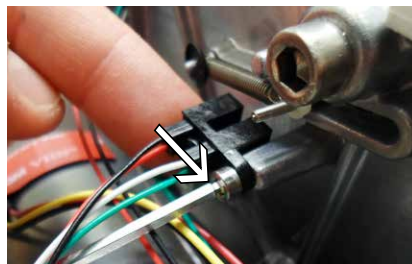

Il pacco batteria è composto da due batterie al piombo da 12 V, 2,3 Ah. La vita di servizio è di 5 anni a seconda della ricarica e dell'utilizzo.

Sostituzione della batteria:

1. Seguire i passaggi da 1 a 6 nel capitolo "Apertura del sollevatore".
2. Cerca di non danneggiare l'etichetta di avvertenza sulla parte superiore della batteria, ad esempio piegando le estremità dell'etichetta.

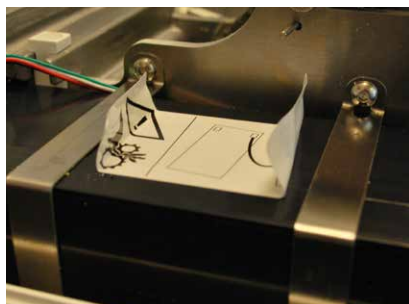

3. Svitare le due staffe metalliche dal telaio utilizzando una chiave a brugola da 2,5 mm.

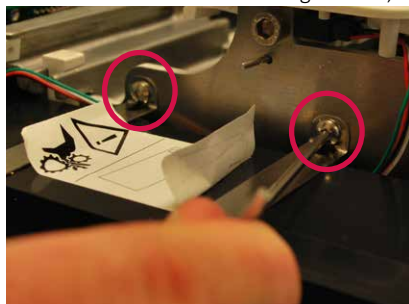

4. Sollevare il pacco batteria dal sollevatore.

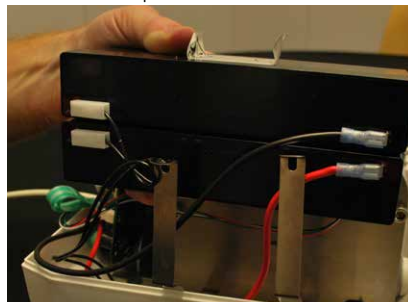

4. Quando le batterie vengono rimosse dal sollevatore, scollegare tutti e quattro i cavi.

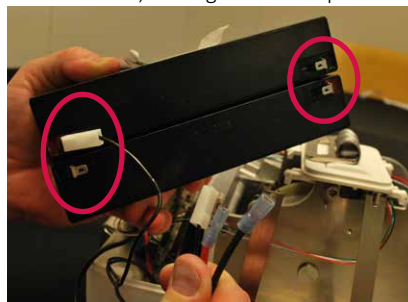

5. Inserire le nuove batterie e ricollegare i cavi. Assicurarsi che le batterie siano collegate allo stesso modo di prima del cambio.
6. Fissare i cavi tra la batteria (all'esterno delle staffe in acciaio) e il coperchio del sollevatore.
7. Seguire i passaggi da 1 a 3 in ordine inverso per completare la sostituzione della batteria.

1. Seguire i passaggi da 1 a 6 nel capitolo "Apertura del sollevatore".
2. Rimuovere il connettore sul cavo di comando manuale dal circuito stampato (PCB) premendo il piccolo lucchetto di plastica sul lato sinistro.

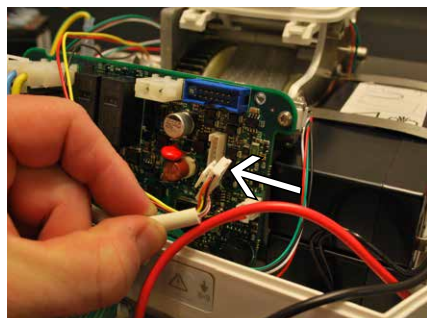

3. Rimuovere le due viti dal supporto del cavo con un cacciavite torsionometrico da 10 mm (T10).

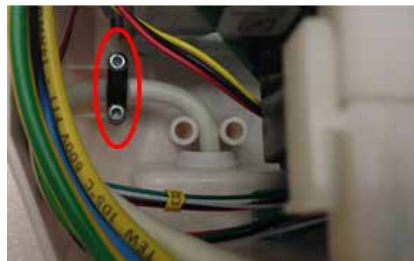
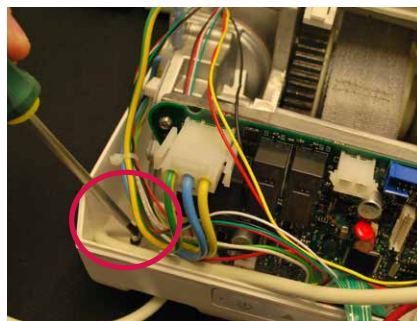

4. Rimuovere la guarnizione in gomma dal coperchio.

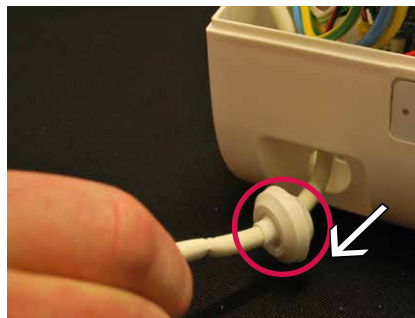

5. Estrarre il cavo e il connettore attraverso il foro.

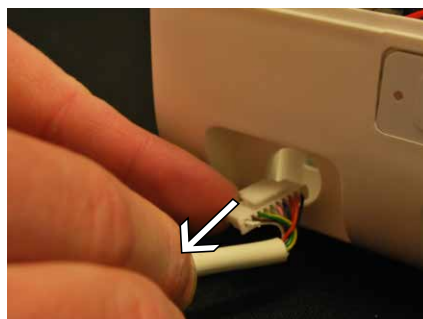

6. Ripetere i passaggi in ordine inverso per collegare il nuovo comando manuale.

Se il comando manuale è danneggiato/rotto, il cavo può essere tagliato per facilitare la rimozione del comando manuale e del cavo.

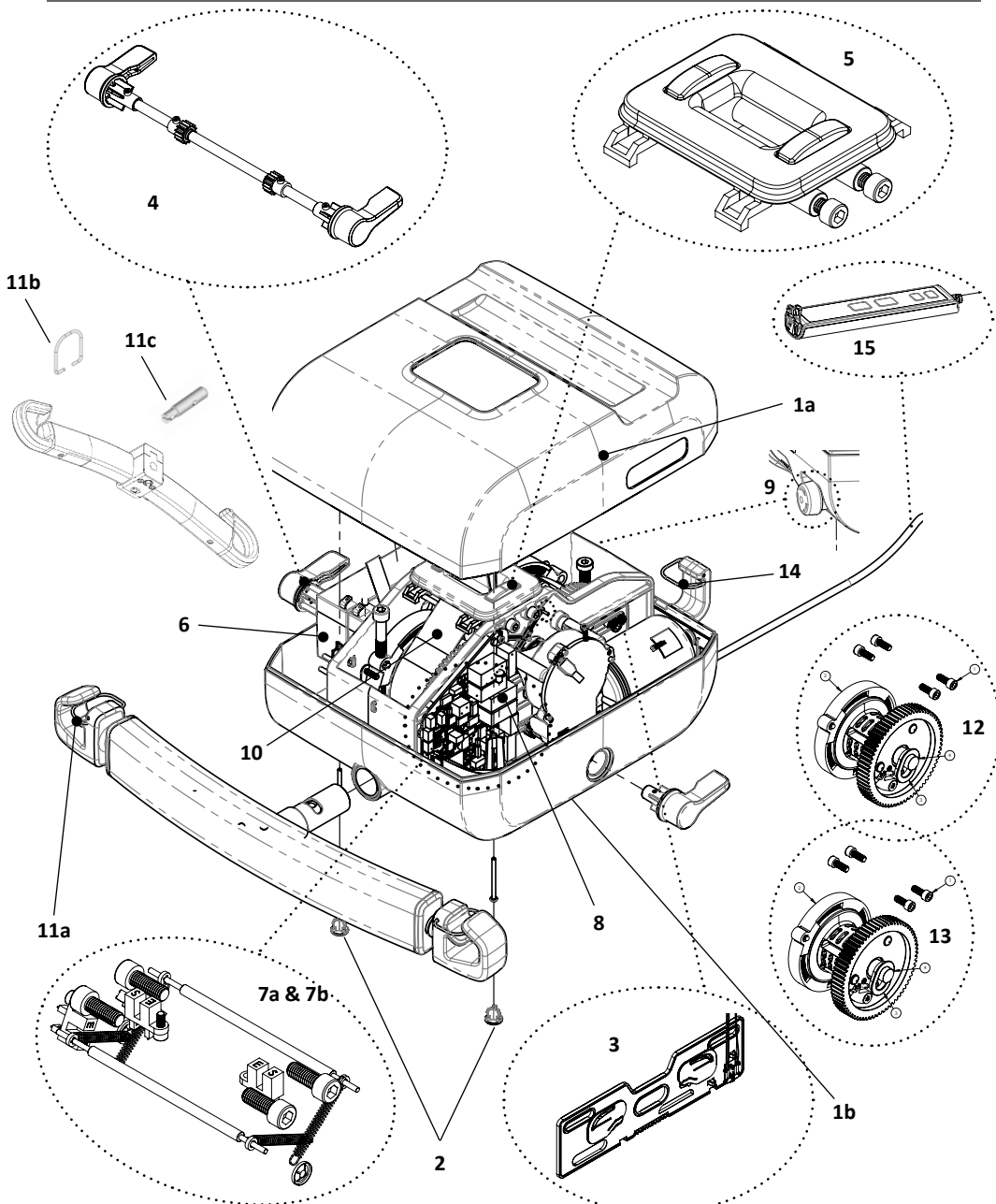

Tutti i pezzi di ricambio per i sollevatori a soffitto sono venduti come kit. Le parti evidenziate da un cerchio puntate mostrano i kit disponibili. L'elenco dettagliato con le parti incluse è riportato sulla pagina successiva.

Numero kit (vista esplosa)	Parte n.	Kit parti di ricambio	Incluso nel kit	Quantità di pezzi nel kit
1a	71460	Coperchio superiore Roomer S - kit	Vite PT WN1452 K30x40 fzb	2
			Coperchio superiore Roomer S	1
1b	92936	Coperchio inferiore Roomer S kit	Coperchio 54055 Etichetta sulle specifiche del cliente (è necessaria la figura dell'etichetta originale)	1
2	71445	Piede sollevatore mobile - kit	Piede sollevatore mobile	20
3	71446	Cursore Roomer S - kit	Vite MC6LS M6x16	3
			Vite MC6S M6x16 A2	4
			Cursore con sensore	2
4	71447	Interruttore Roomer S - kit	Leva interruttore Roomer S	2
			Cursore albero	1
			Vite MC6S M3x12 A2	4
			10015-N08 Mekanex	2
			Cuscinetto a scorrimento 8x9x3	2
5	71448	Finecorsa superiore Roomer S - kit	Guida cinghia Roomer S	1
			Interruttore di arresto cinghia Roomer S	2
			Albero tendicinghia Roomer S	2
			Vite MC6S M6x16 A2	4
6	71449	Sollevatore a soffitto a batteria - kit	CT2.3-12_Batteria	2
			3M VHB 5930 Nastro biadesivo	2
6	71450	Sollevatore a soffitto a batteria - kit	CT2.3-12_Batteria	10
			3M VHB 5930 Nastro biadesivo	10
7a	71451	Sensore arresto cinghia Roomer S - kit	Sensore arresto cinghia con cavo 350	1
			Sensore arresto cinghia con cavo 400	1
			Sensore protezione tendicinghia 2	1
			Sensore protezione tendicinghia 1	1
			Protezione tensione cinghia a molla	4
			Rondella in plastica BTG	4
			Rondella-LB-A-4816	2
			Albero protezione tensione cinghia	2
			Vite MC6S M3x8 A2-70	4
			Vite MC6S M6x16 A2	4
			Scorricinghia	2
			Fascette per cavi 2,5x100	3

Numero kit in vista esplosa	Parte n.	Kit parti di ricambio	Incluso nel kit	Quantità di pezzi nel kit
7b	71551	Protezione antitensione nastro Roomer S – kit, per telaio modificato (dopo la data 2021.10.05, vedere l’etichetta del prodotto sul sollevatore)	Come 7a ma per il sollevatore a soffitto prodotto dopo ottobre 2021.	
8	71452	Scheda di circuito Roomer S - kit	Scheda a circuito stampato principale Roomer S 220 kg	1
			Vite MC6S M3x8 A2-70	3
non nella vista	54437	Batteria a bottone CR_1025_BN	Batteria a bottone per circuito principale	1
9	71489	Arresto di emergenza sollevatori portatili - kit	Arresto di emergenza 16	1
10a	71483	Cinghia di sollevamento sollevatore a soffitto - kit	Cinghia di sollevamento	1
10b	71494	Cinghia di sollevamento a soffitto SWL 300 kg/660 lbs - kit	Cinghia di sollevamento per Altair, Roomer S ed HeliQ con SWL con lunghezza di sollevamento 1720 mm	1
11a	71455	Barra di sospensione a soffitto telescopica a molla - kit	Molla	10
11b	72803	Clip di bloccaggio per barra di sospensione	Clip per barre di sospensione 72754, 72755, 72757, 55751, 55764, 92938	10
11c	92764	Albero barra di sospensione Altair, Roomer S	Per il montaggio della barra di sospensione 55751 e 55764	1
12	71453	Rullo cinghia in sneso orario Roomer S -kit	Vite MC6S M6x16 A2	4
			Rullo cinghia in senso orario	1
			Boccola per albero rullo cinghia	2
			Albero rullo cinghia	1
13	71454	Rullo cinghia in sneso antiorario Roomer S -kit	Vite MC6S M6x16 A2	4
			Rullo cinghia in senso antiorario	1
			Boccola per albero rullo cinghia	2
			Albero rullo cinghia	1
14a	71456	Molla gancio per gamba Altair Roomer S - kit	Molla	5
non nella vista	92974	Molla rivestita per gancio Altair Roomer S - kit	Molla per gancio 92956	5
15	71457	Comando manuale Altair Roomer S - kit	Comando manuale per sollevatori portatili	1
			Morsetto pressacavo cc12	1
			Vite PT WN1452 K30x10 FZB	2
non nella vista	71470	Caricabatterie Europa sollevatore a soffitto - kit	Caricabatterie	1
			Cavo caricabatterie Europa	1
			Supporto per comando manuale	1
			Cinturino ad anello per supporto	1

Numero kit in vista esplosa	Parte n.	Kit parti di ricambio	Incluso nel kit	Quantità di pezzi nel kit
non nella vista	71471	Caricabatterie Gran Bretagna, sollevatore a soffitto - kit	Caricabatterie	1
			Cavo caricabatterie Gran Bretagna	1
			Supporto per comando manuale	1
			Cinturino ad anello per supporto	1
non nella vista	71472	Caricabatterie Giappone, sollevatore a soffitto - kit	Caricabatterie	1
			Cavo caricabatterie Giappone	1
			Supporto per comando manuale	1
			Cinturino ad anello per supporto	1
non nella vista	71473	Caricabatterie Nord America, sollevatore a soffitto - kit	Caricabatterie	1
			Cavo caricabatteria Nord America	1
			Supporto per comando manuale	1
			Cinturino ad anello per supporto	1
non nella vista	71491	Caricabatterie Australia, sollevatore a soffitto - kit	Caricabatterie	1
			Cavo caricabatterie Australia	1
			Supporto per comando manuale	1
			Cinturino ad anello per supporto	1
non nella vista	90407	Miglioramento del colore RAL9016		1
non nella vista	71811	Kit vite di copertura 10 pz.	Vite di copertura	10
non nella vista	92972	Pannello di controllo secondario RoomerS, Altair, HeliQ	Pannello a membrana Roomer S Altair HeliQ	1
non nella vista	92973	Kit portabatterie	54905 Portabatterie RoomerS	1
			55629 Tubi termoretraibili	1

1. Attivare l'arresto di emergenza.



2. Capovolgere il sollevatore. Fare attenzione al sensore di arresto della cinghia.



3. Rimuovere i piedini in gomma più vicini alla barra di sospensione del sollevatore Roomer S.



4. Svitare le due viti (TX10) che tengono insieme i coperchi. Le viti si trovano nella parte inferiore dei fori per i piedini in gomma.



5. Ruotare il sollevatore e rimuovere il coperchio inclinandolo leggermente verso il lato opposto del pannello di comando fino a sentire "clic".



6. Scollegare sempre il cavo della batteria quando il coperchio è aperto.

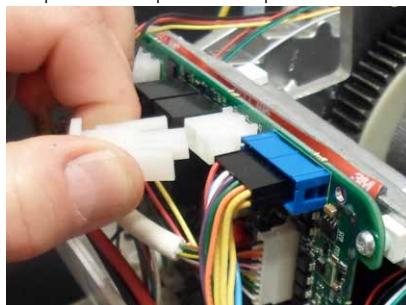

1. Assicurarsi che tutti i cavi siano collegati come prima.
2. Assicurarsi che nessun cavo sia stato schiacciato.
3. Seguire i passaggi da 1 a 6 nel capitolo “Apertura del sollevatore” in ordine inverso.

Ricordarsi di collegare il cavo della batteria prima di chiudere il sollevatore!

Non dimenticare i piedini in gomma!

Ripristino dell’allarme di manutenzione — Roomer S

Al termine della manutenzione bisogna ripristinare l’allarme di manutenzione.

- Collegare il sollevatore al computer tramite “Applicazione dati e manutenzione”. Nel software, cliccare su manutenzione e accedere con le credenziali di accesso. Fare clic sul pulsante “Ripristino allarme manutenzione”.

The screenshot shows the 'Data- och serviceapplikation' interface. The top navigation bar includes 'START', 'ÖVERSIKT', 'STATISTIK', and 'SERVICE'. Below this, there are buttons for 'ÅTERSTÄLL SERVICEALARM' (circled in red), 'LIPPODATA FÖRBJUDARE', and 'STÄLL IN REALTIDSKLOCKA'. The 'SERVICE' section displays 'Senaste service' (2015-04-08) and 'Nästa service/öfalle' (2016-04-07). The 'FELRAPPORTER' table lists maintenance events:

Datum	Tid	Beskrivning
2016-02-23	13:55	Nedjärkning i nödsituationer
2016-02-23	13:55	Nedjärkning i nödsituationer
2016-02-23	13:55	Nedjärkning i nödsituationer
2016-02-23	13:55	Nedjärkning i nödsituationer
2016-02-23	13:55	Nedjärkning i nödsituationer

Sostituzione del comando manuale - Roomer S

1. Seguire i passaggi da 1 a 6 nel capitolo "Apertura del sollevatore".
2. Rimuovere il connettore sul cavo di comando manuale dal circuito stampato (PCB) premendo il piccolo lucchetto di plastica sulla parte superiore.

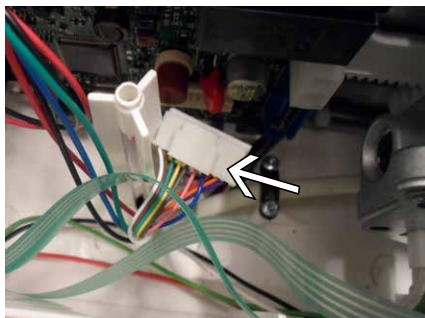
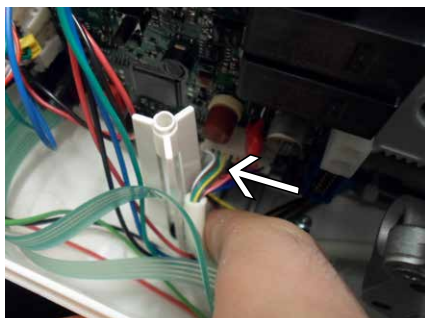

3. Rimuovere la guarnizione in gomma dal coperchio.



4. Utilizzare ad esempio un cacciavite per capovolgere il cavo sul lato sinistro come illustrato nelle immagini qui sotto.



5. Estrarre il cavo e il connettore attraverso il foro. Se il comando manuale è danneggiato, è possibile tagliare il cavo e sarà più facile estrarlo.

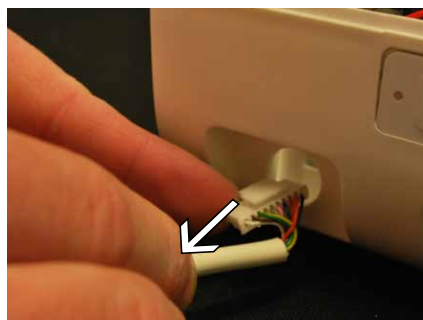

6. Ripetere i passaggi in ordine inverso per collegare il nuovo comando manuale.

La cinghia può essere sostituita senza smontare l'uscita della cinghia.

1. Trascinare completamente la cinghia sbloccata dal contatore del rullo della cinghia.

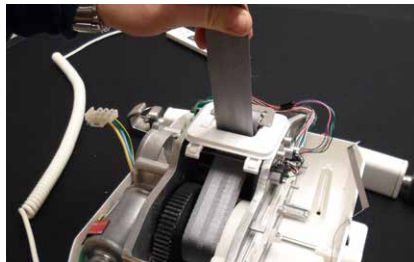

2. Creare una grande ansa.

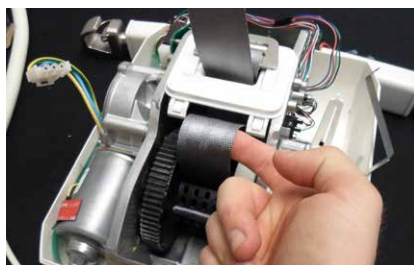

3. Usare ad esempio una spatola per creare un'ansa sull'altro lato.



5. Usa l'interruttore Roomer S o il comando manuale per ruotare il rullo della cinghia e afferrare l'ansa.



6. Usare di nuovo la spatola per estrarre l'estremità della cinghia con il piccolo perno.



7. Riportare il rullo della cinghia con l'aiuto dell'interruttore Roomer S o del comando manuale. Afferrare la cinghia.



Nota! Non ruotare l'interruttore Roomer S senza tenere il rullo della cinghia poiché la molla si srotola. Se si lascia cadere il rullo della cinghia, riavvolgerlo per 9,5 giri dalla fessura del rullo della cinghia con un perno di metallo.

7. Rimuovere il perno, la cinghia è ora allentata.



8. Se è necessario rimuovere entrambe le cinghie, ripetere l'operazione sul lato opposto.

9. Inserire la nuova cinghia/cinghie attraverso l'uscita come illustrato nell'immagine qui sotto.

Nota! Assicurati che le etichette nere su entrambe le cinghie siano una di fronte all'altra.

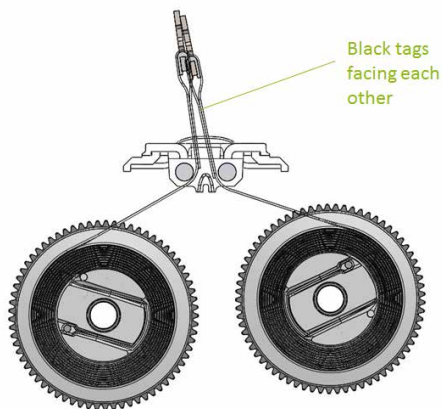

Nota! Assicurarsi che le cinghie siano posizionate sul lato corretto del dispositivo di protezione della tensione della cinghia.

- La cinghia deve entrare nel rullo della cinghia attraverso la fessura con il perno di metallo.
- L'estremità della cinghia deve essere fissata con il perno metallico nella fessura accanto alla quella in cui è stato inserito il rullo della cinghia.
- Il perno dovrebbe essere appoggiato il più possibile nella fessura. Tendere la cinghia per far entrare il perno nella fessura.

Il pacco batteria è composto da due batterie al piombo da 12 V, 2,3 Ah. La vita di servizio è di 5 anni a seconda della ricarica e dell'utilizzo.

Sostituzione della batteria:

1. Seguire i passaggi da 1 a 6 nel capitolo "Apertura del sollevatore".

Nota! Assicurarsi di rimuovere il cavo della batteria che si collega al circuito stampato (non i cavi della batteria posizionati sulla batteria).

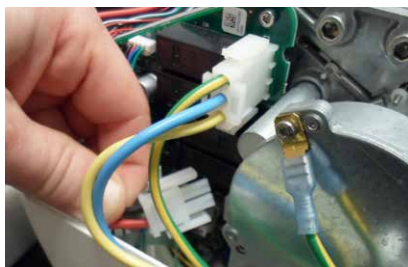

2. Svitare le due staffe metalliche dal telaio utilizzando una chiave a brugola da 2,5 mm.

Avvertimento! Non rimuovere i cavi della batteria mostrati nell'immagine qui sotto! Dovrebbero rimanere fissati fino a quando la vite non viene allentata per evitare cortocircuiti.



3. Adesso - scollegare i cavi che si trovano sulla batteria.

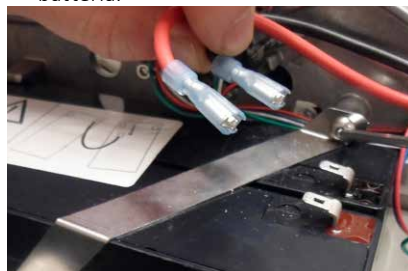

4. Sollevare il pacco batteria dal sollevatore.



5. Quando le batterie vengono rimosse dal sollevatore, scollegare tutti e quattro i cavi.

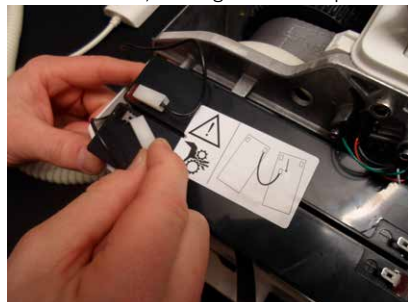

5. Inserire le nuove batterie e ricollegare i cavi.
Assicurarsi che le batterie siano collegate allo stesso modo di prima del cambio.
I connettori delle batterie del circuito stampato e dei terminali della batteria sono codificati a colori. I cavi dall'arresto di emergenza possono essere collegati in qualsiasi ordine.
6. Fissare i cavi tra la batteria (all'esterno delle staffe in acciaio) e il coperchio del sollevatore.
7. Seguire i passaggi da 1 a 5 in ordine inverso per completare la sostituzione della batteria.

HUMAN CARE SWEDEN (HQ)

Årstaängsvägen 21B

117 43 Stockholm

Phone:- +46 8 665 35 00

Fax:- +46 8 665 35 10

E-post: info.se@humancaregroup.com

www.humancare.se

HUMAN CARE CANADA

10-155 Colonnade Road

Ottawa, ON K2E 7K1

Phone:- 613.723.6734

Fax:- 613.723.1058

Email: info.ca@humancaregroup.com

www.humancaregroup.com

HUMAN CARE UNITED STATES

4210 S. Industrial Drive, Suite 160

Austin, TX 78744

Phone: 512.476.7199

Fax: 512.476.7190

Email: info.us@humancaregroup.com

www.humancaregroup.com

NETHERLANDS

Human Care Nederland

Elspeterweg 124

8076 PA Vierhouten

Phone: +31 577 412 171

Fax: +31 577 412 170

info.nl@humancaregroup.com

www.humancare.nl